

5 3 5



5 3 5

1/4 DIN PROCESS CONTROLLER USER'S MANUAL



Table of Contents

	<u>PAGE</u>
CHAPTER 1	
INTRODUCTION	1
535 Modes	1
Order Code, Packaging Information	2
Where To Go Next	2
Text formatting in this manual	2
CHAPTER 2	
BASIC INTERFACE	5
Displays	5
Icons (Lit)	5
Keys	6
Basic Operating Procedures	7
Alarm Operation	8
CHAPTER 3	
INSTALLATION	11
Mounting the Controller	11
Wiring	12
AC Power Input	13
Process Variable Input	13
Digital Input(s)	16
1. Digital Inputs with a Switch or Relay	16
2. Digital Inputs with an Open Collector	16
Remote Setpoint Option	16
Output Modules	17
1. Mechanical Relay Output	17
2. Solid State Relay (Triac) Output	17
3. DC Logic (SSR Drive) Output	18
4. Milliamp Output	18
5. Position Proportioning Output	18
Serial Communications	19
Limit Control	20
CHAPTER 4	
HARDWARE SET UP	21
Hardware Input Types	21
The Process Variable	21
The Remote Setpoint	22
Mechanical Relays	22
Accessing and changing jumpers	23
Adding and Changing output modules	24
Special Communications Module	26
CHAPTER 5	
SOFTWARE CONFIGURATION	27
Menus	27
Parameters	28
Configuration and Operation	29
Where to Go Next	29

About This Manual:

Throughout this User's Manual information appears along the margins (**NOTE:**, **CAUTION!** and **WARNING!**). Please heed these safety and good practice notices for the protection of you and your equipment.

Table of Contents

CHAPTER 5	PAGE
CONTROLLER SET UP (cont'd)	
Text Formatting in This Manual	29
Software Menus and Parameters	30
CONFIG	30
PV1 INPUT	34
PV2 INPUT	36
CUST. LINR.	38
CONTROL	39
ALARMS	41
REM. SETPT.	46
RETRANS.	47
SELF TUNE	48
SPECIAL	50
SECURITY	51
SER. COMM.	52
Parameter Value Charts	50
CHAPTER 6	
TUNING	63
Overview	63
TUNING Menu Parameters	64
TUNING Parameter Value Chart	68
Self Tune Messages and Troubleshooting	70
CHAPTER 7	
APPLICATIONS	71
A. Control Type	71
B. Alarms	72
C. Duplex Control	76
Duplex with reverse and direct acting outputs	77
Duplex with direct and reverse acting outputs	77
Duplex with 2 reverse acting outputs	78
Duplex with a gap between outputs	78
Duplex with overlapping outputs and output limits	79
Duplex with various relative gain settings	79
Duplex with one ON/OFF output	80
Duplex with two ON/OFF outputs	80
D. Slidewire Position Proportioning Control	81
E. Velocity Position Proportioning Control	82
F. Staged Outputs	83
G. Retransmission	83
H. Digital Inputs	84
I. Remote Setpoint	86
J. Multiple Setpoints	87
K. Multiple Sets of PID Values	87
L. Powerback	88
M. Self Tune—Powers POWERTUNE®	89
Pretune by Itself	89
Pretune TYPE 1 and Adaptive Tune	91
Pretune TYPE 2 or TYPE 3 and Adaptive Tune	91
Adaptive Tune by Itself	92
Self Tune with Multiple Sets of PID	94
Self Tune with Time Proportioning Outputs	94

CHAPTER 7	PAGE
APPLICATIONS (cont'd)	
Self Tune with Control Valves	94
N. Ramp-to-Setpoint	94
O. Input Linearization	95
Thermocouple and RTD Linearization	95
Square Root Linearization	95
Custom Linearization	96
P. Load Line	97
Q. Security	97
R. Reset Inhibition	98
S. Process Variable Reading Correction	98
T. Serial Communications	99
U. Cascade Control	100
V. Ratio Control	103
APPENDIX 1	
MENU FLOWCHARTS	A-1
APPENDIX 2	
PARTS LIST	A-3
APPENDIX 3	
TROUBLESHOOTING	A-5
APPENDIX 4	
CALIBRATION	A-7
Preparation for all Input Calibrations	A-8
Thermocouple Cold Junction Calibration	A-9
Analog Milliamp Input Calibration	A-9
Milliamp Output Calibration	A-10
Reset Menu Data	A-11
Hardware Scan	A-12
Slidewire Test	A-12
Quick Calibration Procedure	A-12
APPENDIX 5	
SPECIFICATIONS	A-13
APPENDIX 6	
GLOSSARY	A-17
APPENDIX 7	
ISOLATION BLOCK DIAGRAM	A-23

List of Figures

<u>FIGURE</u>	<u>DESCRIPTION</u>	<u>PAGE</u>
Figure 2.1	Operator Interface	5
Figure 2.2	Before and After Acknowledging an Alarm	8
Figure 3.1	Instrument Panel & Cutout Dimensions	11
Figure 3.2	Attaching mounting collar	11
Figure 3.3	All 535 Terminal Assignments	12
Figure 3.4	AC Power Input Terminals	13
Figure 3.5	Process Variable Terminals	13
Figure 3.6	PV1 and PV2 Wiring for Milliamp, RTD and Voltage Inputs	14
Figure 3.7	PV1 and PV2 Wiring for Milliamp Inputs with Internal and External Power Supply	15
Figure 3.8	Digital input Wiring with a Switch or Relay	16
Figure 3.9	Digital Input Wiring with an Open Collector	16
Figure 3.10	Remote Setpoint Terminals	16
Figure 3.11	Mechanical Relay Output Wiring	17
Figure 3.12	SSR Relay Output Wiring	17
Figure 3.13	DC Logic Output Wiring	18
Figure 3.14	Milliamp Output Wiring	18
Figure 3.15	Position Proportioning Output Wiring	18
Figure 3.16	Serial Communications Terminals	19
Figure 3.17	535 Wiring with Limit Control	20
Figure 4.1	Location of Printed Circuit Boards for Hardware Configuration	21
Figure 4.2	The Microcontroller Circuit Board, the Option Board, and the Power Supply Board	22
Figure 4.3	Representation of Module	25
Figure 4.4	Install Communications Module onto Microcontroller Board	26
Figure 5.1	Menu Flowchart for Set Up	27
Figure 5.2	Independent vs. Dependent Parameters	28
Figure 5.3	Configuration Flowchart	28
Figure 6.1	Access the Tuning Menu Block	63
Figure 7.1	Alarm Examples	75
Figure 7.2	Duplex with reverse and direct acting outputs	77
Figure 7.3	Duplex with direct and reverse acting outputs	77
Figure 7.4	Duplex with two reverse acting outputs	78
Figure 7.5	Duplex with a gap between outputs	78
Figure 7.6	Duplex with overlapping outputs and output limits	79
Figure 7.7	Duplex with various relative gain settings	79
Figure 7.8	Duplex with one ON/OFF output	80
Figure 7.9	Duplex with two ON/OFF outputs	80
Figure 7.10	Staged Outputs Example	83
Figure 7.11	Combinations of Closed Digital Inputs for Each Setpoint (based on BCD logic)	84
Figure 7.12	Pretune TYPE 1, 2 and 3 with Adaptive Tune	90
Figure 7.13	Noise Band Calculation Example	92

FIGURE	DESCRIPTION	PAGE
Figure 7.14	Noise Band Values for Temperature Inputs	93
Figure 7.15	Deadtime and Time Constant	93
Figure 7.16	Square Root Linearization Formula	95
Figure 7.17	15-point Linearization Curve	96
Figure 7.18	Load Line Example	97
Figure 7.19	Heat Exchanger Control Loop for Steam Supply	100
Figure 7.20	Cascade Control of Product Temperature	101
Figure 7.21	Ratio Control in Mixing Application	103
Figure A4.1	535 Rear Terminals for Calibration	7
Figure A4.2	Flowchart Calibration Menus	7
Figure A4.3	Jumper Locations on the Microcontroller Circuit Board	8
Figure A4.4	Input Calibration Wiring	8
Figure A4.5	Thermocouple/Cold Junction Calibration Wiring	9
Figure A4.6	Analog mA Input Calibration Wiring	10
Figure A4.7	Analog mA Input Jumper Positions	10
Figure A4.8	Milliamp Output Calibration Wiring	11
Figure A4.9	Output Module Menu Cycle	11
Figure A4.10	Slidewire Test Wiring	12

Table of Contents

CHAPTER 1

INTRODUCTION



From its surge-resistant power supply to its rugged construction, the 535 process controller is designed to ensure the integrity of your process with maximum reliability — hour after hour, day after day. The isolated inputs and outputs guard against the dangers of electrical interference, the front face meets NEMA 4X standards for watertight operation and exposure to corrosive environments, and the solid metal housing and sturdy rubber keys enhance durability and ESD protection.

The 535 has been engineered to be the industry's most user-friendly process controller. With three digital display areas — two offering up to 9 characters of true alphanumeric — the 535 effectively eliminates the cryptic messages that could confuse even the most experienced operator. The bright, crisp display is vacuum fluorescent, and offers much better readability than any other display technology. Additional operator-friendly features include: custom programmable alarm messages, illuminated keys, and an easy-to-use menu system.

The 535 is the most accurate instrument in its class. With a sampling rate of ten times per second, it is ideal for demanding pressure and flow applications. The 535 also offers a universal process input and modular, field interchangeable outputs that allow more flexibility than ever before. The RS-485 serial communications interface allows the controller to utilize sophisticated software routines and high speed hardware to provide exceptionally fast and accurate transmission of data. The 535 also offers sophisticated control algorithms, including Moore Industries' **exclusive Adaptive Tune** which constantly analyzes your process and makes modifications to the tuning parameters to ensure you're always under control.

Thank you for selecting the 535 Process Controller — the most sophisticated instrument in its class. It will provide you with years of reliable, trouble-free performance.

535 MODES

There are three operating modes for the 535 controller:

OPERATION, the default mode of the controller. When the 535 is operating, you can change setpoints, select manual control and change output level, acknowledge alarms and monitor conditions.

SET UP, also referred to as configuration. Here you set up the basic functions of the instrument such as input and output assignments, alarm types and special functions.

TUNING, where you configure control function parameters for Proportional, Integral and Derivation (PID). Use periodically to optimize the control performance of the instrument.

ORDER CODE, PACKAGING INFORMATION

Compare the product number to the ordering code on page 3 to determine the outputs and options installed on the 535. The product number is printed on the label on the top of the controller case.

Included with this 535 are:

- a 535 User's Manual
- mounting hardware
- 1 sheet of Engineering unit adhesive labels

WHERE TO GO NEXT

- To become more familiar with the 535 interface, continue to Chapter 2.
- For important hardware installation guidelines, see Chapters 3 and 4.
- For a detailed description of all the software menus and parameters of the 535, follow through Chapters 5 and 6. Appendix 1 can be used as a basic guideline to these parameters.

TEXT FORMATTING IN THIS MANUAL

Feature

KEYS

ICONS
MENUS
PARAMETERS
PARAMETER VALUES
DISPLAY MESSAGES

Format

SET PT

or

SET PT

DISPLAY

DISPLAY

OUT, ALM
CONFIG., TUNING,
CYCLE TM:1, MIN.OUT2
OFF, SETPOINT, LAST OUT.
TOO HOT, OUT%,

535 – **0** **0**

	Order Code
Output 1: Control	
None	0
Mechanical Relay (5 amp)	1
Analog (milliamp)	2
Solid State Relay (triac) (1 amp)	3
DC Logic (SSR drive)	4
Output 2: Control, Alarm, or Retransmission	
None	0
Mechanical Relay (5 amp)	1
Analog (milliamp)	2
Solid State Relay (triac) (1 amp)	3
DC Logic (SSR drive)	4
Output 3: Control, Alarm, Retransmission, or Loop Power	
None	0
Mechanical Relay (5 amp)	1
Analog (milliamp)	2
Solid State Relay (triac) (1 amp)	3
DC Logic (SSR drive)	4
Loop Power	5
Output 4: Alarm, Retransmission, or Loop Power	
None	0
Mechanical Relay (0.5 amp, 24 V)	1
Analog (milliamp)	2
Solid State Relay (triac) (0.5 amp, 24 V)	3
DC Logic (SSR drive)	4
Loop Power	5
Options	
<i>Enter "0" if not desired</i>	
Slidewire Feedback for Position	
Proportioning Output	A
24 VAC/24 VDC Operation	F
Slidewire and 24 VAC/24 VDC	G
Remote Setpoint	B
Profile Controller Option	C
Remote Setpoint and Profile	E
Set of Five Digital Inputs	D
CE Certification	H
Five Digital Inputs and CE Certification	J
Serial Communications	
<i>Enter "0" if not desired</i>	
RS-485 Serial Communications	S

Note 1: Capability for position proportioning output is specified by ordering 535-11xAxxx00, 535-33xAxxx00, or 535-44xAxxx00. Note 2: Capability for velocity proportioning output is specified by ordering 535-11xxxxx00, 535-33xxxxx00, or 535-44xxxxx00. Note 3: Up to two outputs may be used for alarms. Note 4: All outputs are interchangeable modules. Note 5: The mechanical relay and solid state relay modules are derated to 0.5 amp at 24 Vac when used as the fourth output.

CHAPTER 2 BASIC INTERFACE

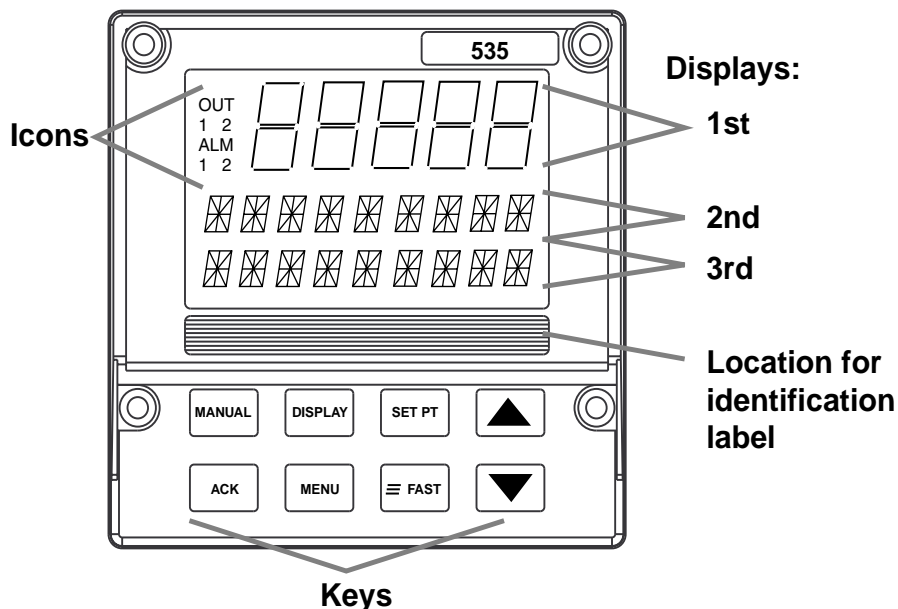

Figure 2.1
Operator Interface

DISPLAYS

The display strategy of the 535 Process Controller is the same for all control modes.

1st Display (five 7-segment digits)

- For the process variable value.

2nd Display (nine 14-segment digits)

- For the setpoint, deviation, output level or valve position (if available)
- In TUNING or SET UP mode, for the parameter name.
- Upon power up, indicates the current setpoint.

3rd Display (nine 14-segment digits)

- For alarm messages, loop name, errors, etc.
- In TUNING or SET UP mode, the value or choice of parameter shown in the 2nd display.

ICONS (LIT)

OUT Indicates either 1) relay output is energized; or 2) analog output is greater than 0%.















ALM1 Indicates the respective alarm (one) is active.

ALM2 Indicates the respective alarm (two) is active.

OUT	OUT	OUT
1	2	1 2

ALM	ALM	ALM
1	2	1 2

KEYS

	FAST : Has no independent function. Press to modify the function of another key (see below).	
	MANUAL : Press to toggle between manual and automatic control. When lit, indicates the unit is under manual control.	
	SET PT : Press to select the active SP. When lit, indicates that a setpoint other than the primary (e.g., RSP, SP2) is active.	
	DISPLAY : Press to toggle through values in the 2nd display for setpoint, ramping setpoint, deviation, PV1, PV2, output and valve position (each, if available). In Tuning or Set Up mode, press to return controller to Operation mode (display will show current setpoint).	
		▲ : Press to increase the value or selection of displayed parameter.
		FAST+▲ : Press to scroll through values at a faster rate.
		▼ : Press to decrease the value or selection of displayed parameter.
		FAST+▼ : Press to scroll through values at a faster rate.
		ACK : Press to acknowledge (an) alarm(s). When lit, indicates there is an acknowledgeable alarm.
		MENU : In Operation Mode, press to access the Tuning Menu. In Set Up or Tuning mode, press to advance through a menu's parameters. (Use FAST+MENU to advance to the next menu.) When lit, indicates the controller is in Set Up mode.
		FAST+MENU : Press to access the Set Up menus. In Set Up mode, press to advance through menus. (Use MENU by itself to access the parameters of a particular menu.)

BASIC OPERATING PROCEDURES

Use the following as a quick guide to key operating functions of the 535.

To select /change a setpoint

1. Use **DISPLAY** key to toggle display to SetPoint.
2. Use **SET PT** key to toggle to active setpoint.
Before the newly selected setpoint is made active, there is a two-second delay to prevent any disruptive bumps. If the setpoint displayed is ramping, RAMPING will show the 3rd display.
3. To change value, press ▲ or ▼ .

To change from auto to manual control (bumpless transfer)

1. When in automatic control, press the **MANUAL** key at any time, except while in the **TUNING** mode.
2. The **MANUAL** key will light in red, and the 2nd display will immediately change to indicate current output level.

To change from manual to auto

1. When in manual control, press **MANUAL** at any time except while in the **TUNING** or **SET UP** mode.
2. The 2nd display will not change, and the **MANUAL** key will no longer be lit once control changes.

To change manual output values

1. Make sure the controller is under manual control.
2. Use the **DISPLAY** key to toggle 2nd display to output level.
3. Use the ▲ or ▼ key to change the value.

To override security

If a locked operation is attempted, SECURITY appears in the 2nd display for two seconds).

1. Use the ▲ and ▼ keys to quickly enter the security code, which will show in the 3rd display. The starting value is 0.
Note: Two seconds of key inactivity will clear the display.
2. If the code is correct, CORRECT appears in the 3rd display. The display will clear after two seconds, allowing full access.
4. If code is incorrect, INCORRECT appears in the 3rd display. INCORRECT will disappear after two seconds, and a new security code can then be entered.
5. The controller will revert back to full security lock after one minute of key inactivity.

To display control output value

1. Toggle **DISPLAY** key until the 2nd display shows OUT followed by the output percentage. This value is the PID output.
 - In duplex applications, this value does not directly refer to the output signal (refer to the Chapter 7 section on Duplex Control for details.)
 - For on/off outputs, the output value shown is either ON or OFF.
 - For duplex applications with two on/off outputs, the OUT tag is not shown. In this case, the status of both outputs is shown in the following manner: 1:ON 2:OFF (1 and 2 are the respective outputs).

NOTE:

See the glossary in Appendix 6 for explanation of ramping and target setpoint. Also refer to the applications in Chapter 7.

To display the active PID set

1. Press **MENU** to reach Tuning Mode.
2. In **TUNING** Mode, press **MENU** to reach the correct Menu parameter.
3. The active PID set will have an asterisk (*) on both sides of the value.

NOTE:

All alarms are software alarms unless tied to an output relay in the **SET UP** mode. See Chapters 5 and 7 for details on alarms.

ALARM OPERATION

Alarms may be used in systems to provide warnings of unsafe conditions. All 535 operators must know how the alarms are configured, the consequences of acknowledging an alarm and how to react to alarm conditions.

Alarm Indication

- lit icons **ALM 1** and/or **ALM 2**
- lit **ACK** key
- displayed alarm message

Acknowledgable alarms meet the first two of these conditions.

Non-acknowledgable alarms only meet the first condition (only icon is lit).

Figure 2.2
Before and After Acknowledging
an Alarm

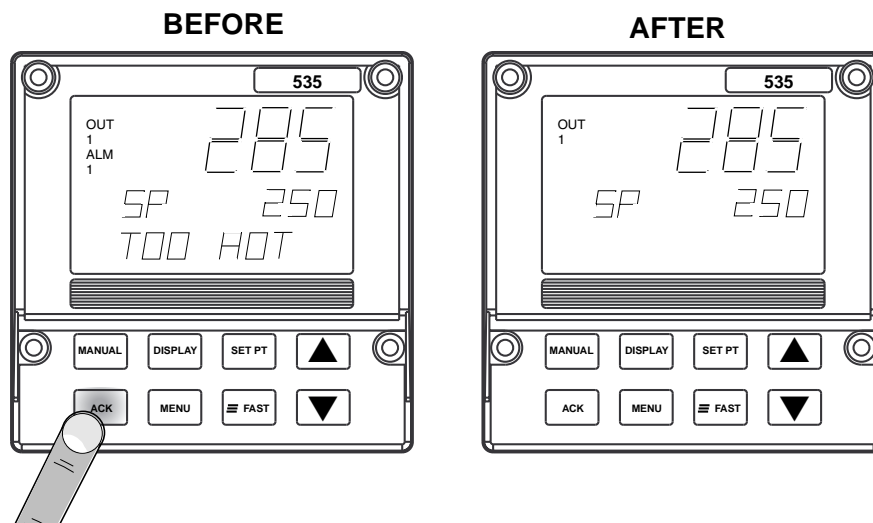

NOTE:

Powering down the 535 acknowledges/clears all latched alarms. When powering up, all alarms will be reinitialized.

To acknowledge an alarm(s):

1. To acknowledge Alarm 1, press **ACK** once.
2. To acknowledge Alarm 2, press **ACK** twice.
3. If both alarms are activated, press **ACK** once to acknowledge Alarm 1, then again to acknowledge Alarm 2.
4. The message and alarm icon disappear.

Latching Alarms

If an alarm is set up to be latching (for details, see Chapter 5) then, in general, it must be acknowledged in order to clear the alarm and release the relay (if applicable). A non-latching alarm will clear itself as soon as the process leaves the alarm condition.

Limit Sequence

An alarm can be configured to be both latching and non-acknowledgeable. In this case, the alarm is acknowledgeable only after the process has left the alarm condition. This is similar to the function of a limit controller.

More on Alarms

For more details on how to set up alarms and for examples of various ways alarms can be set up, refer to the section on Alarms in Chapter 7.

CHAPTER 3 INSTALLATION

MOUNTING THE CONTROLLER

The 535 front face is **NEMA 4X rated** (waterproof). To obtain a waterproof seal between the controller and the panel, follow these directions:

1. The 535 fits in a standard 1/4 DIN cutout. Mount the 535 in any panel with a thickness from .06 in. to .275 in. (1.5 mm to 7.0 mm).
2. Figure 3.1 shows the controller and panel dimensions. The panel cutout must be precise, and the edges free from burrs and waves.

Figure 3.1
Instrument Panel & Cutout
Dimensions

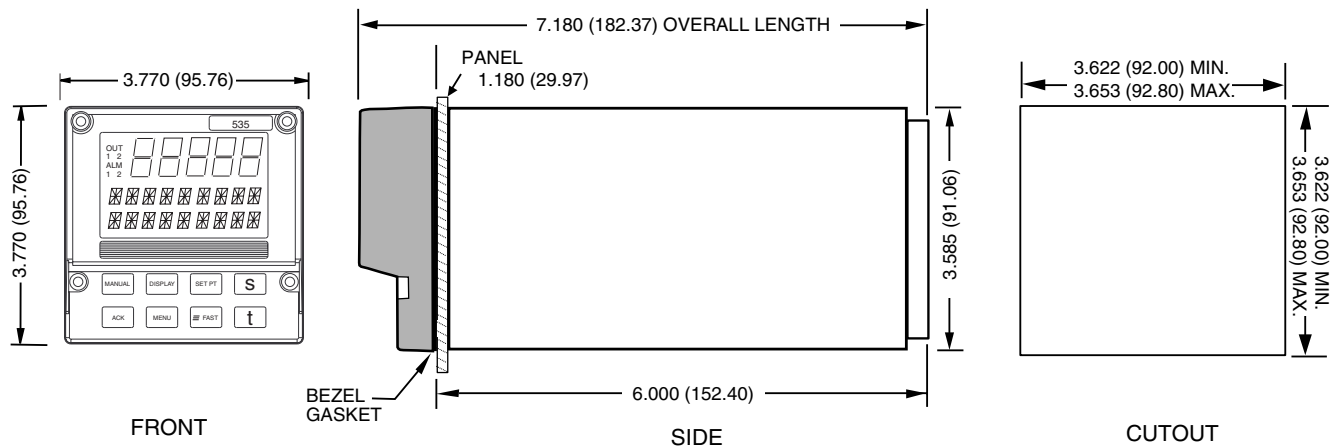

3. Place bezel gasket around the controller case (starting at the back of controller). Then, slide the gasket against the back of the bezel.
4. With the bezel gasket in place, insert the 535 into the panel cutout from the front of the panel.
5. Slide the mounting collar over the back of the case, as shown in Figure 3.2. The collar clip edges will lock with matching edges on the controller case.

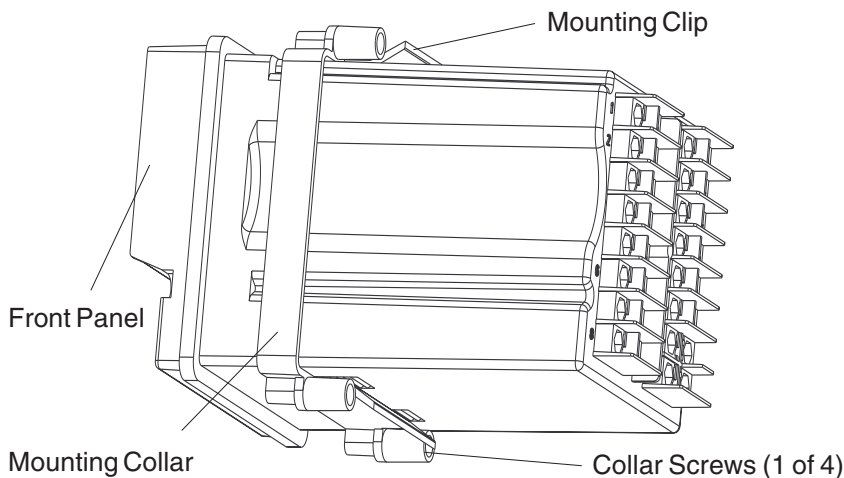

Figure 3.2
Attaching mounting collar

Install /Wire

CAUTION!

The enclosure into which the 535 Controller is mounted must be grounded.

WARNING!

Avoid electrical shock. Do not connect AC power wiring at the source distribution panel until all wiring connections are complete.

6. Insert the four mounting collar screws from the rear of the collar. Gradually tighten the screws (using a Phillips #2 screwdriver) to secure the controller against the panel.
7. If there is difficulty with any of the mounting requirements, apply a bead of caulk or silicone sealant behind the panel around the perimeter of the case.

WIRING

Powers 535 controllers are thoroughly tested, calibrated and “burned in” at the factory, so the controller is ready to install. Before beginning, read this chapter thoroughly and take great care in planning a system. A properly designed system can help prevent problems such as electrical noise disturbances and dangerous extreme conditions.

1. For improved electrical noise immunity, install the 535 as far away as possible from motors, relays and other similar noise generators.
2. Do not run low power (sensor input) lines in the same bundle as AC power lines. Grouping these lines in the same bundle can create electrical noise interference.
3. All wiring and fusing should conform to the National Electric Code and to any locally applicable codes.
4. An excellent resource about good wiring practices is the IEEE Standard No. 518-1982 and is available from IEEE, Inc., 345 East 47th Street, New York, NY 10017, (212) 705-7900.

Diagrams on the next three pages serve as guides for wiring different types of process inputs. The shaded areas on the diagrams show which rear terminals are used for that type of wiring.

*Figure 3.3
All 535 Terminal Assignments
Actual 535 device only has top and bottom numbers of each column of terminals marked.*

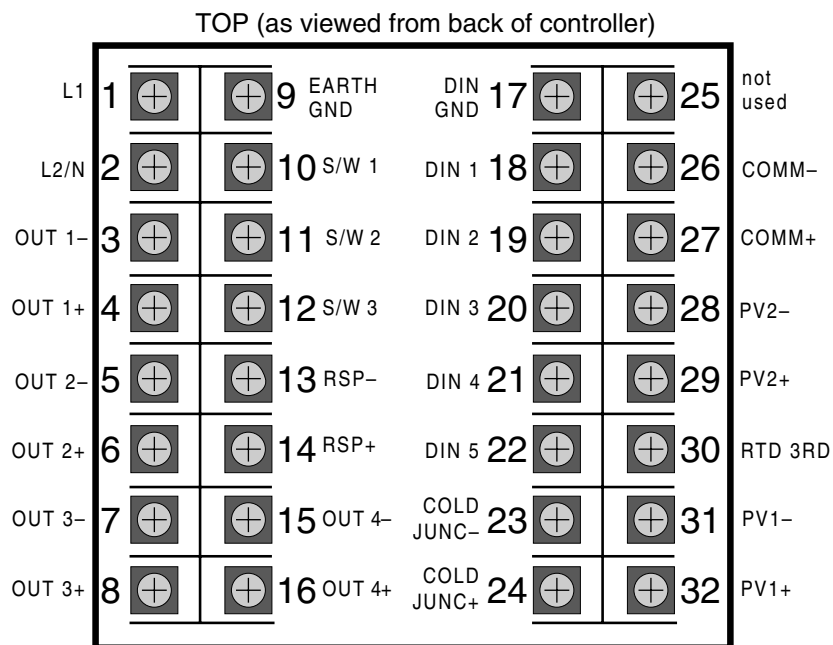

WARNING!

ELECTRIC SHOCK HAZARD!

Terminals 1 and 2 carry live power. DO NOT touch these terminals when power is on.

WARNING!

Terminal 9 must be grounded to avoid potential shock hazard, and improved noise immunity to your system.

AC Power Input

Terminals 1 and 2 are for **power**. Terminal 9 is the **earth ground**.
Use a 0.5 Amp, 250 V, fast-acting fuse in line with your AC power connection.

NOTE:

When wiring to a 240 Volt system, an additional 0.5 Amp, 250V, fast-acting fuse is required on L2.

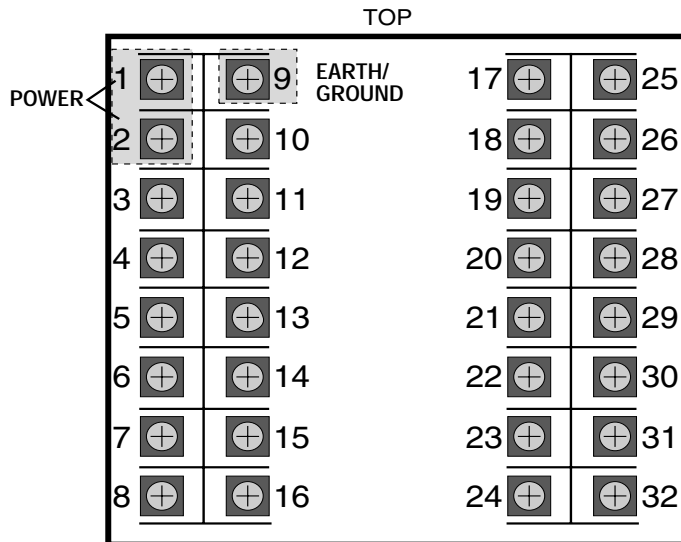

Screws must be tight to ensure good electrical connection

Figure 3.4
AC Power Input Terminals

CAUTION!

Do not run low power (sensor input) lines in the same bundle as AC power lines. Grouping these lines in the same bundle can create electrical noise interference.

Process Variable Input

The 535 accommodates the following types of process variable inputs:

- Thermocouple Input
- RTD Input
- Voltage Input
- Milliamp Input with External Power Supply
- Milliamp Input with Internal Power Supply

Each type of input can be wired for PV1 (terminals 31 and 32) or for PV2 (terminals 28 and 29).

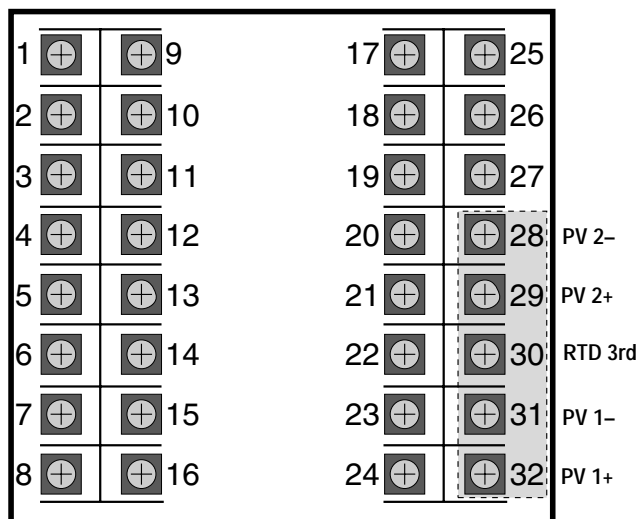

Figure 3.5
Process Variable Terminals

Install /Wire

NOTE:

Typically, in the U.S., negative leads are red.

Figure 3.6
PV1 and PV2 Wiring for Milliamp,
RTD and Voltage Inputs.

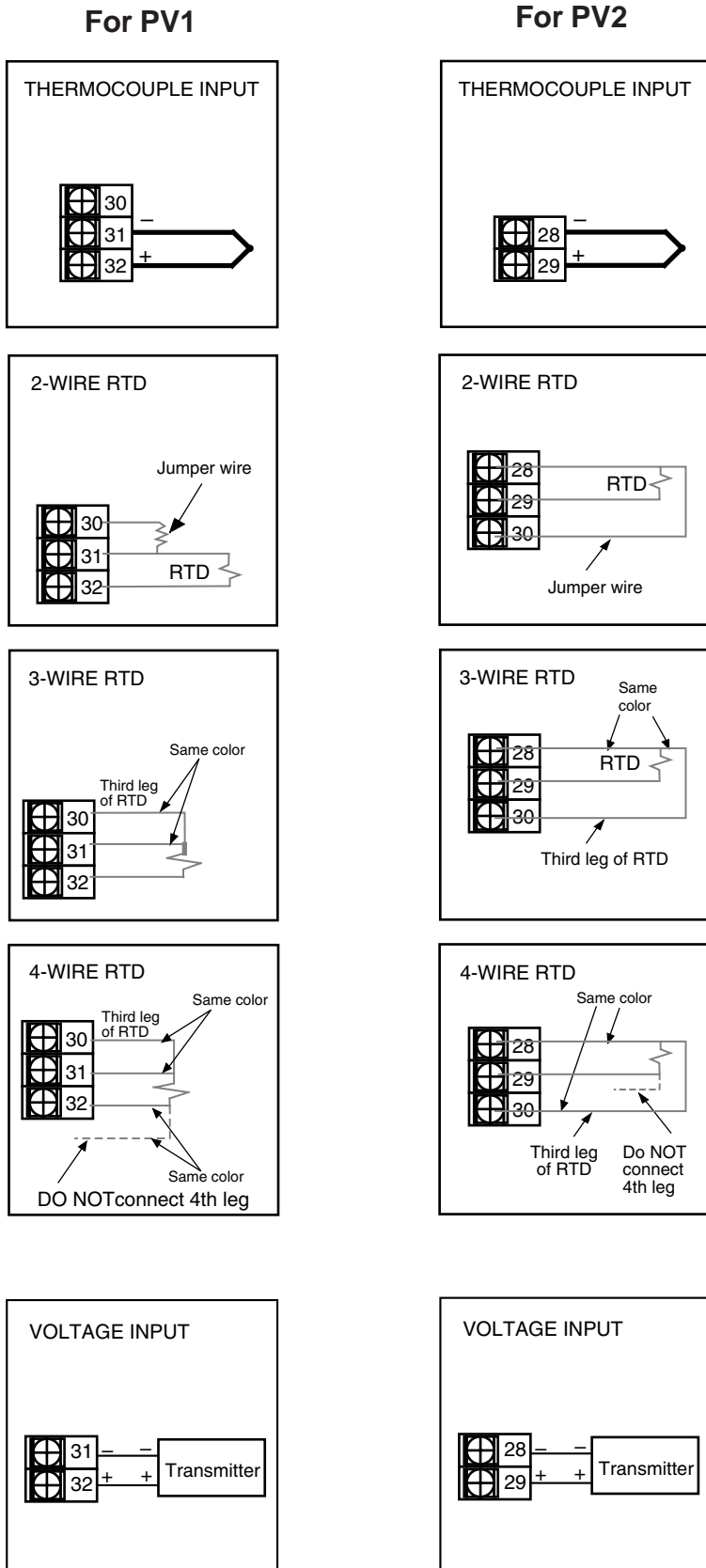

For PV1

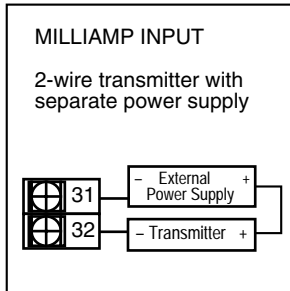

For PV2

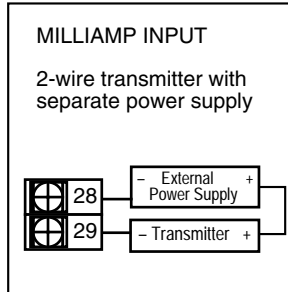
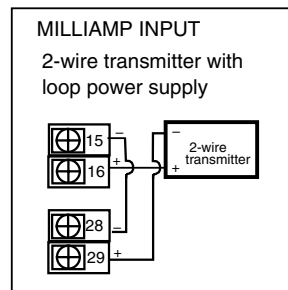
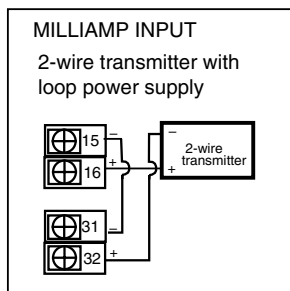
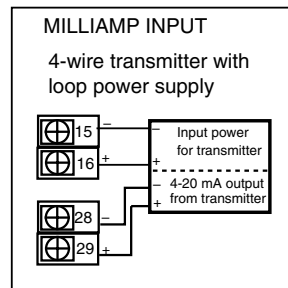
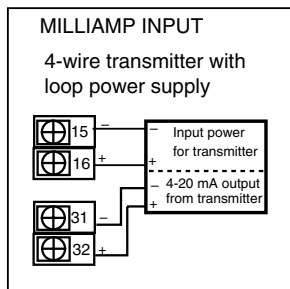

Figure 3.7
PV1 and PV2 Wiring for Milliamp
Inputs with Internal and External
Power Supply



NOTE:

To use loop power, there must be a loop power module installed in the 3rd or 4th output socket. Compare the controller product number with the order code in Chapter 1 to determine if the 535 has a loop power module installed. To install a loop power module, refer to Chapter 4.



Digital Input(s)

Digital inputs can be activated in three ways: a switch (signal type), closure of a relay, or an open collector transistor. Digital inputs are only functional when that option is installed (via hardware) The controller detects the hardware and supplies the appropriate software menu.

Figure 3.8
Digital input Wiring with a Switch or Relay

1. Digital Inputs with a switch or relay

Wire the switch/relay between terminal 17 and the specific digital input terminal (Figure 3.8).

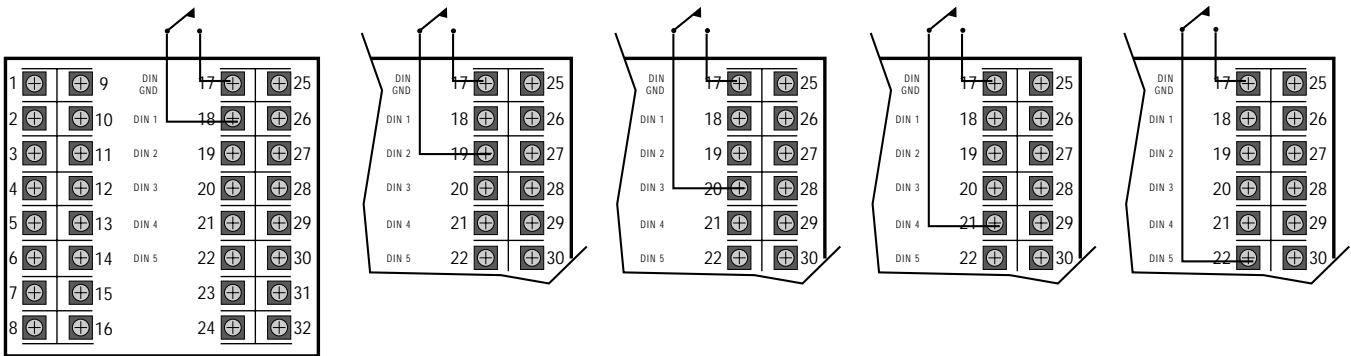
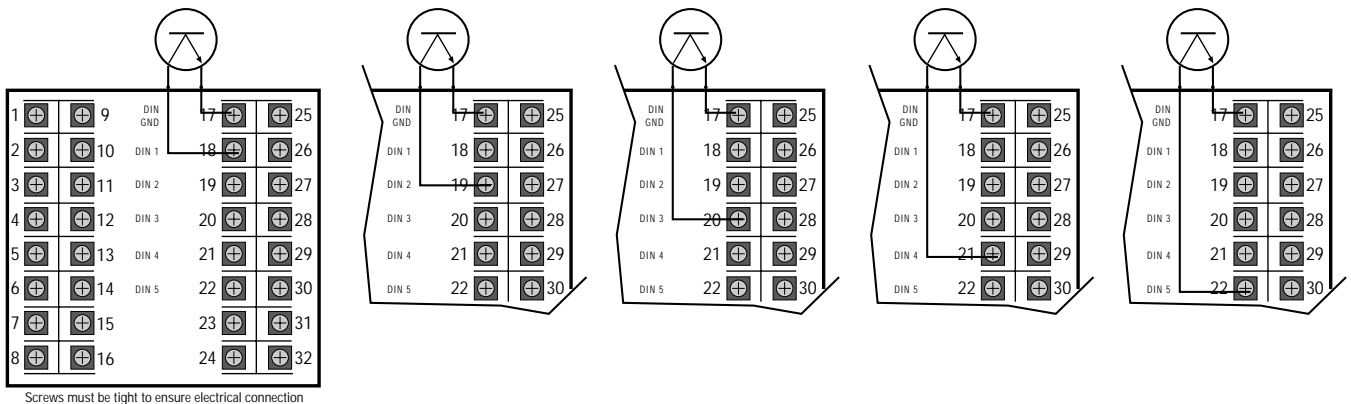

Figure 3.9
Digital Input Wiring with an Open Collector

2. Digital Inputs with an Open Collector

An open collector is also called a transistor. Wire the transistor between terminal 17 and the specified digital input terminal (Figure 3.9)



Remote Setpoint Option

Use terminals 13 and 14 to connect the remote setpoint signal (see Figure 3.10).

Figure 3.10
Remote Setpoint Terminals

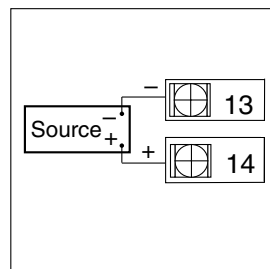

OUTPUT MODULES

The 535 output modules are used for control, alarms and retransmission. The four output module types are: **Mechanical Relay**, **Solid State Relay (Triac)**, **DC Logic (SSR Drive)** and **Analog (Milliamp)**

To install these modules, plug them into any of the four output sockets on the printed circuit boards (refer to Chapter 4). The wiring is the same whether the modules are used for control, alarm or retransmission.

The diagrams on the next two pages are a guide for properly connecting the various outputs. To find out which module(s) have been installed in the controller, compare the product number on the controller label with the section Order Code in Chapter 1. This section also includes a diagram of how to wire a position proportioning output, a special application using two mechanical or two solid state relays.

1. Mechanical Relay Output

- Output 1 is always Control 1.
- Outputs 1, 2 and 3 are jumper selectable for normally open and normally closed on the power supply circuit board.
- Output 4 is always configured for normally open and has reduced voltage and current ratings (see Specifications).

NOTE:

Refer to Figure 4.2 for location of the corresponding jumpers. Second input jumper connector on the option board must be in either *mA* (milliamp) or *V* (voltage) position.

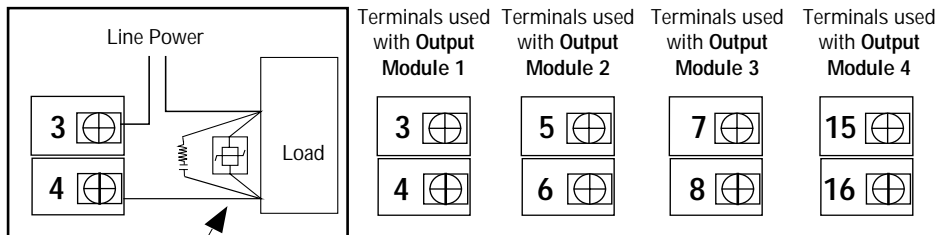

Recommend use of both MOV and snubber

Figure 3.11
Mechanical Relay Output wiring

2. Solid State Relay (Triac) Output

- Output 1 is always Control 1.
- Respective jumper J1, J2 or J3 must be set to normally open for SSR (Triac) output.
- Output 4 is always configured for normally open and has reduced voltage and current ratings (see Specifications).

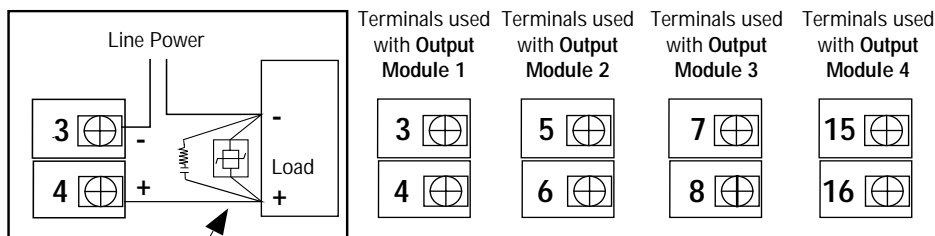

Recommend use of both MOV and snubber

Figure 3.12
SSR Relay Output Wiring

3. DC Logic (SSR Drive) Output

- Output 1 is always Control 1.
- Respective jumper J1, J2 or J3 must be set to normally open for DC Logic output.
- Output 4 is always configured for normally open.

Figure 3.13
DC Logic Output Wiring

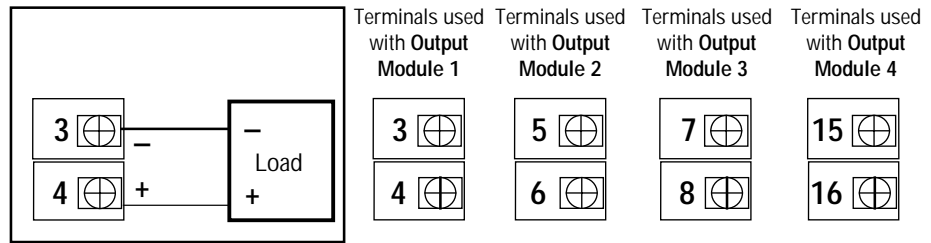

4. Milliamp Output

- Output 1 is always Control 1.
- Respective jumper J1, J2 or J3 must be set to normally open for Milliamp output.

Figure 3.14
Milliamp Output Wiring

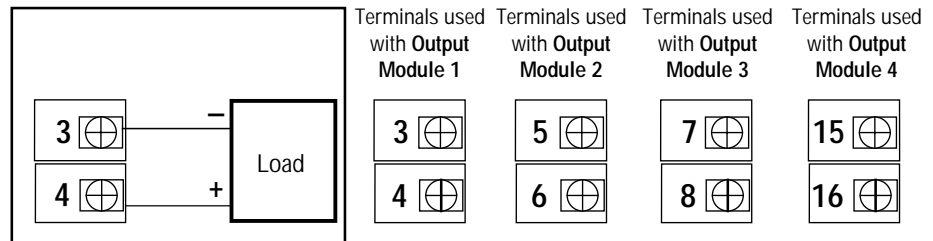

5. Position Proportioning Output (with or without Slidewire Feedback)

Figure 3.15
Position Proportioning Output
Wiring

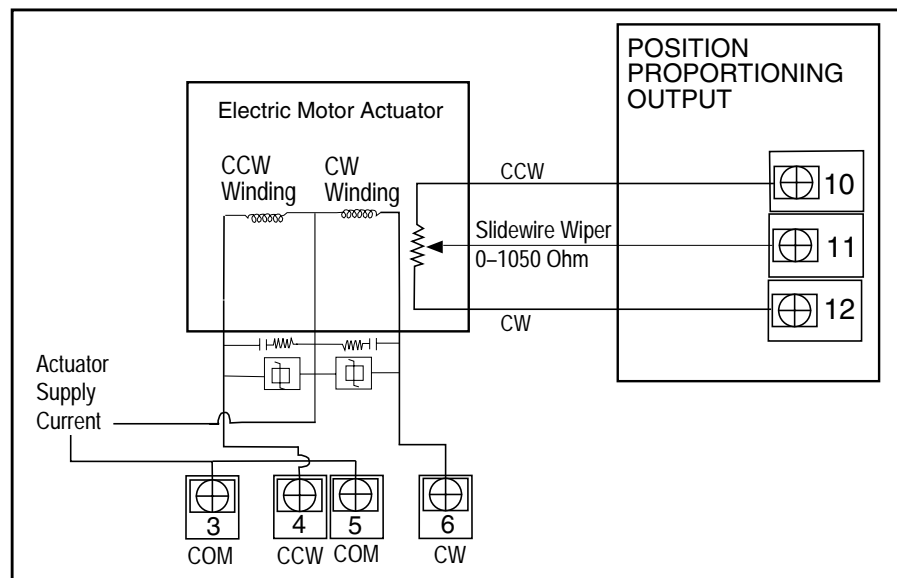

- Mechanical relay or solid state relay modules must be installed in output sockets 1 and 2.
- When using velocity control (no slidewire feedback), there are no connections at terminals 10, 11 and 12.
- Use of the slidewire feedback is optional

Serial Communications

A twisted shielded pair of wires should be used to interconnect the host and field units. Belden #9414 foil shield or #8441 braid shield 22-gauge wire are acceptable for most applications. The foil shielded wire has superior noise rejection characteristics. The braid shielded wire has more flexibility. The maximum recommended length of the RS 485 line is 4000 feet. Termination resistors are required at the host and the last device on the line. Some RS 485 cards/converters already have a terminating resistor. We recommend using our RS-232/RS-485 converter. The communication protocol is asynchronous bidirectional half-duplex, hence the leads are labelled *Comm +* and *Comm -*

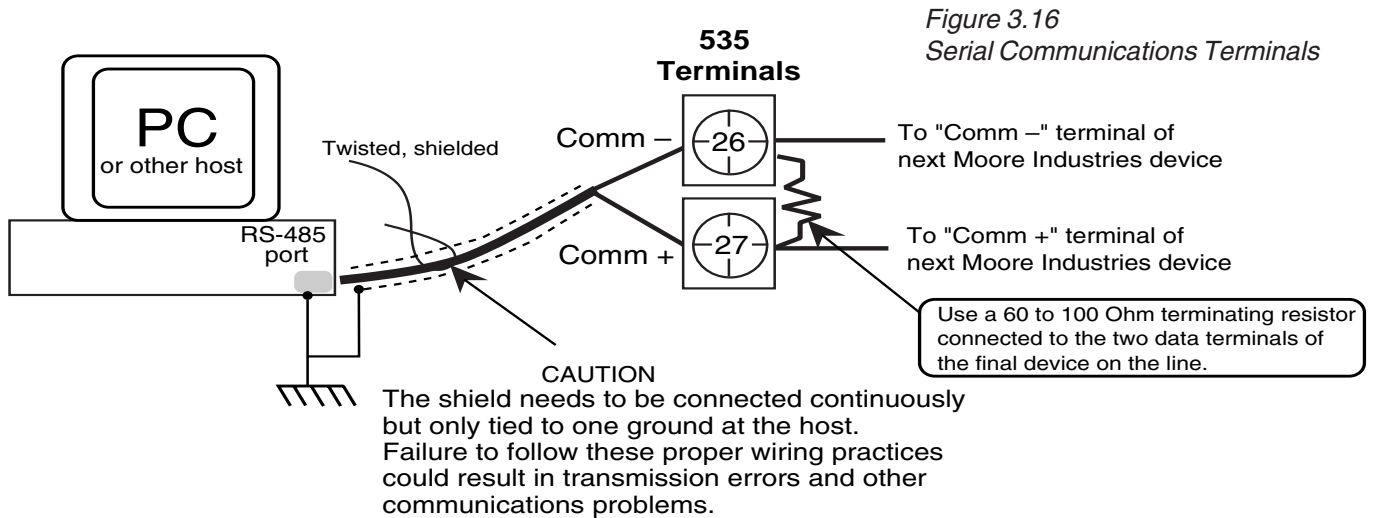

Limit Control

Temperature applications where abnormally high or low temperature conditions pose potential hazards for damage to equipment, product and operator. For such applications, we recommend the use of an **FM-approved temperature limit device** in conjunction with the process controller. This wiring example illustrates a typical application using the 535 Process Controller with a 353 Limit Controller.

Figure 3.17
535 Wiring with Limit Control

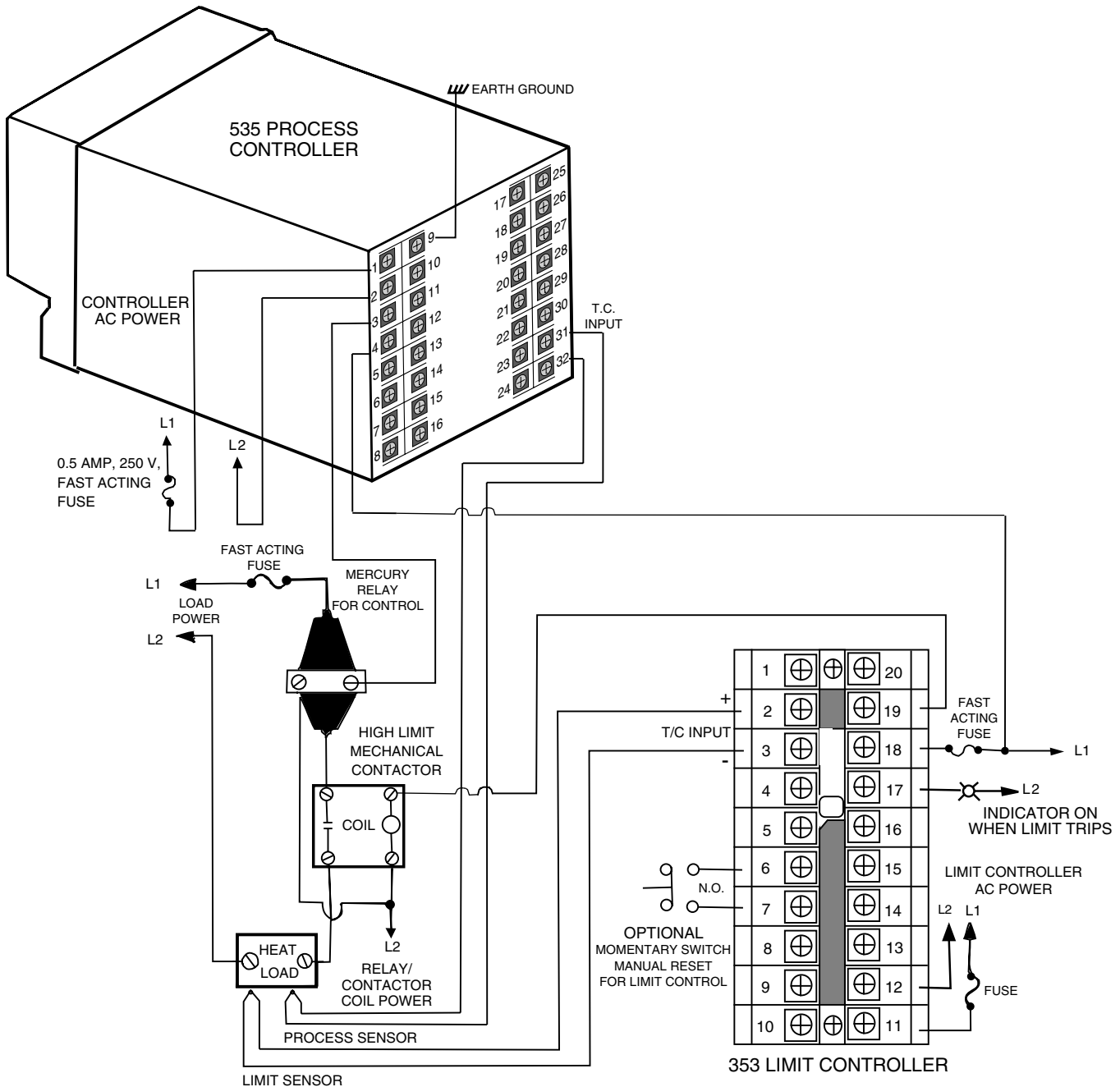

CHAPTER 4 HARDWARE SET UP

Hardware configuration determines the available outputs as well as the type of input signal. The 535 controller comes factory set with the following:

- All specified modules and options installed (for details, refer to the Order Code in Chapter 1).
- Process variable and remote setpoint set to accept a milliamp input.
- Relay outputs set to normally open.

NOTE: Hardware configuration of the controller is available at the factory; Consult a Moore Industries application engineer for details.

Altering the factory configuration of the 535, requires accessing the circuit boards, and locating the jumpers and output modules (see Figure 4.1).

1. With the power off, loosen the four front screws, and remove them.
2. Slide chassis out of the case by pulling firmly on the bezel.

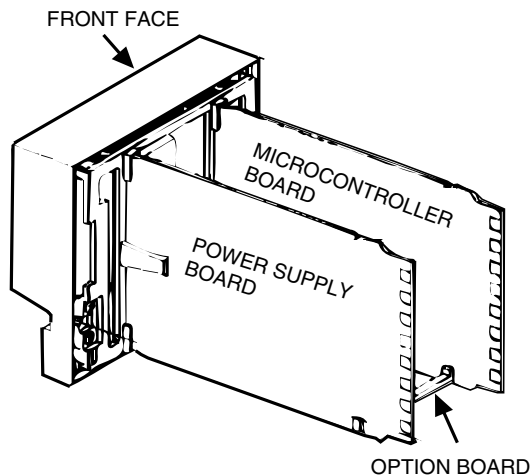

Figure 4.1
Location of Printed Circuit Boards for Hardware Configuration

A detailed view of the circuit boards appears in Figure 4.2.

After configuring the hardware, or if no changes are necessary, continue setting up the process as needed.

HARDWARE INPUT TYPES

The Process Variable

The 535 accepts several different types of process variable signals. Set a jumper location to specify the type of input signal. Set the signal range in the software (see Chapter 5 for software menus, or Chapter 7 for applications).

The jumpers for the process variable are located on the Microcontroller Circuit Board (see Figure 4.2). The factory default is Milliamp. Locations are marked as follows:

V	Voltage
MA	Milliamp
TC ▼	Thermocouple with downscale burnout
TC ▲	Thermocouple with upscale burnout
RTD	RTD

NOTE: Thermocouple downscale and upscale burnout offers a choice in which direction the controller would react in the event of thermocouple failure. For example, in heat applications, typically, it is desirable to fail upscale (TC s) so that the system does not apply more heat.

NOTE:

Changing the jumpers means moving the jumper connector. The jumper connector slips over the pins, straddling two rows of pins. The printed circuit boards are labeled next to the jumpers.

The Remote Setpoint

Figure 4.2 shows the location of the remote setpoint jumper. **The factory default is milliamp.** Choose from the following settings:

- V Remote setpoint with voltage signal (jumper removed)
- MA Remote setpoint with milliamp signal (jumper installed)

Mechanical Relays

There are three output module sockets on the Power Supply Circuit Board, and one output module on the Option Board (see Figure 4.2). The mechanical relay on the Power Supply Board may be configured for either normally open (NO) or normally closed (NC). A jumper located next to each socket determines this configuration. All relay outputs are factory set to NO (normally open).

Figure 4.2
(from the top) The Microcontroller Circuit Board, the Option Board, and the Power Supply Board

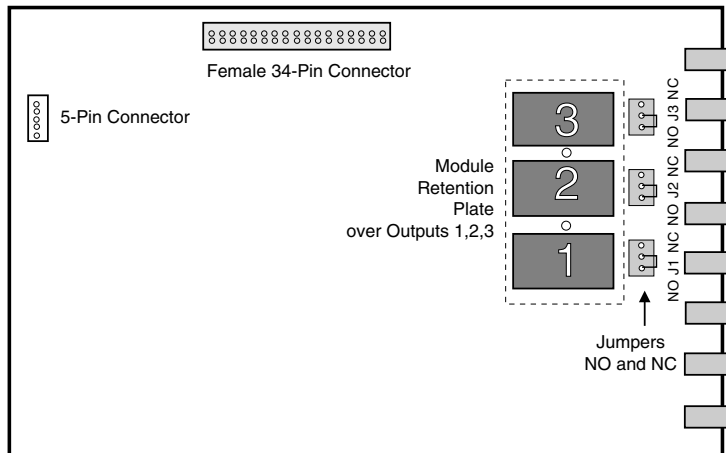
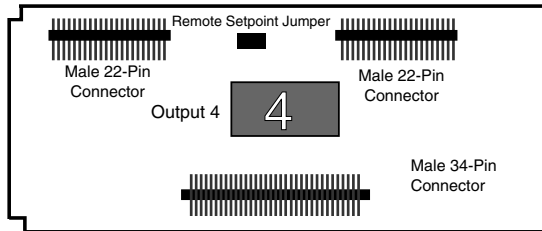
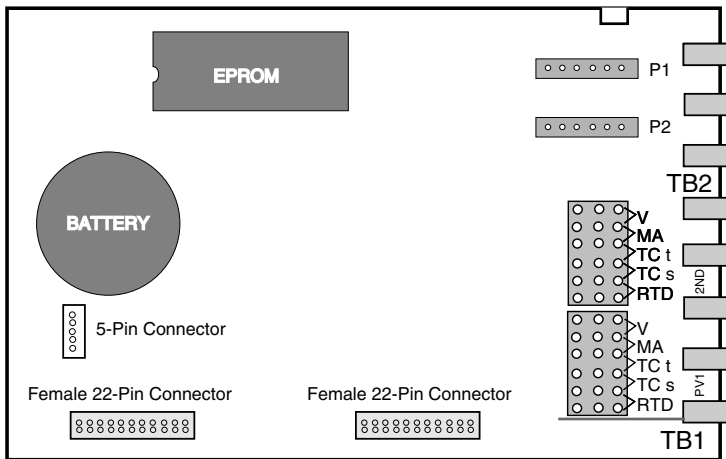

ACCESSING AND CHANGING JUMPERS

Follow these instructions to change jumpers for the Process Variable, Remote Setpoint and Digital Inputs:

Equipment needed: Needle-nose pliers (optional)
Phillips screwdriver (#2)
Wrist grounding strap

1. With power off, loosen two front screws, and remove them.
2. Slide the chassis out of the case by pulling firmly on the bezel.
3. Use Figure 4.2 to locate the jumper connector to change.
4. Using the needle nose pliers (or fingers), pull straight up on the connector and remove it from its pins, as shown in Photo 4. Be careful not to bend the pins.

CAUTION!!

Static discharge can cause damage to equipment. Always use a wrist grounding strap when handling electronics to prevent static discharge.

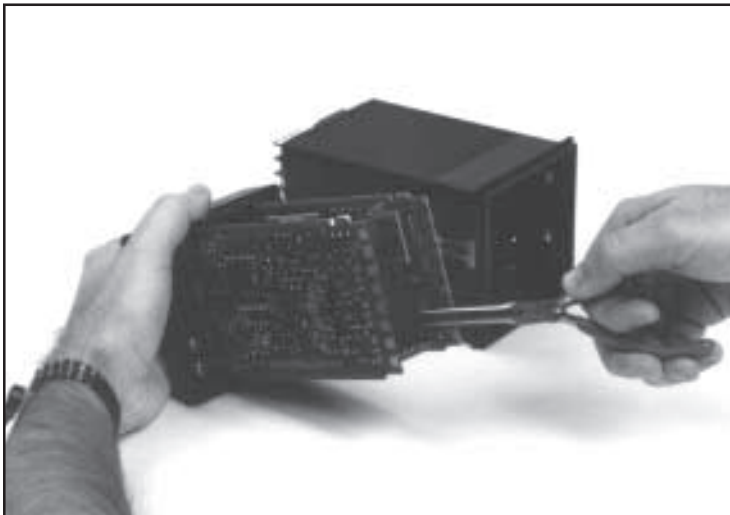

4. Remove Jumpers

5. Find the new location of the jumper connector (again, refer to Figure 3.2). Carefully place it over the pins, then press connector straight down. Make sure it is seated firmly on the pins.
6. Make any other jumper changes as needed. **To alter output modules, please refer to the next section, starting with Step #3.**
7. To reassemble the controller, properly orient the chassis with board opening on top. Align the circuit boards into the grooves on the top and bottom of the case. Press firmly on the front face assembly until the chassis is all the way into the case.
If it is difficult to slide the chassis in all the way, make sure the screws have been removed (they can block proper alignment), and that the chassis is properly oriented.
8. Carefully insert and align screws. Tighten them until the bezel is seated firmly against the gasket. **Do not overtighten.**

ADDING AND CHANGING OUTPUT MODULES

The 535 has provisions for four output modules. A controller ordered with output module options already has the modules properly installed. Follow these instructions to add modules, change module type(s) or change module location(s).

Equipment needed: Wrist grounding strap
 Phillips screwdriver (#2)
 Small flat blade screwdriver
 Wire cutters

1. With power off, loosen two front screws, and remove them.
2. Slide the chassis out of the case by pulling firmly on the bezel.
3. Use a flat screwdriver to carefully pry apart the clips that hold the front face assembly to the chassis, as in Photo 3. Separate the printed circuit board assembly from the front face assembly. Use care not to break the clips or scratch the circuit boards.
4. As shown in Photo 4, carefully pry apart, using hands or a small flat screwdriver, the smaller Option board and the Power Supply board (the one with 3 modules).
5. **To change modules 1, 2 or 3:**
Output modules 1, 2, and 3 are firmly held in place by a retention plate and tie wrap. Carefully snip the tie wrap with a wire cutter. To prevent damage to the surface mount components, ALWAYS snip the tie wrap on TOP of the Retention Plate, as shown in Photo 5.
Remove the retention plate.



3. Pry Clips

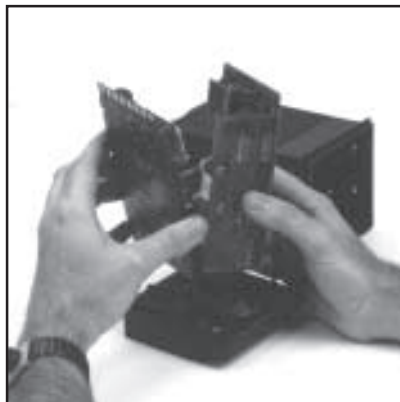

4. Separate Boards

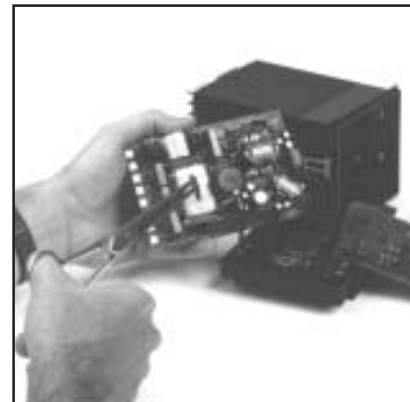

5. Remove Retention Plate

6. To change module 4:

- Output Module 4 (on the Option board) is also held in place by a tie wrap. Snip tie wrap to remove module as shown in Photo 6.
- Figure 4.3 shows a representation of an output module. Inspect the module(s) to make sure that the pins are straight.
- To install any module, align its pins with the holes in the circuit board, and carefully insert the module in the socket. Press down on the module until it is firmly seated; refer to Photo 8.

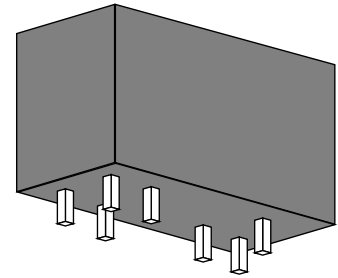
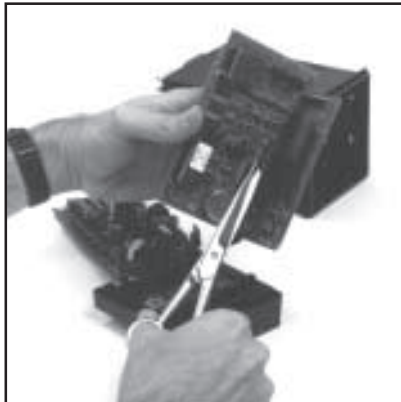
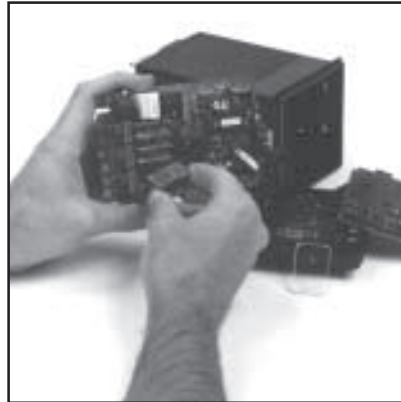

Figure 4.3
Representation of Module



6. Snip Tie Wrap



8. Add/Change Module

9. Replace tie wraps for all the modules (the Retention Plate and Output Module 4) with new ones before reassembling the controller.
Failure to use the tie wraps may result in loosening of the module and eventual failure. All separately ordered modules should come with a tie wrap. Extra sets of tie wraps are available by ordering Part #535-665.
10. Rejoin the circuit boards by aligning the pins of their connectors, then squeezing the board(s) together. Make sure that all three printed circuit boards are properly seated against one another; check along side edges for gaps. Make sure the cable assemblies are not pinched.
11. To reattach the board assembly to the front face assembly, align the boards (with the open area on top) into the slots of the front face assembly. The clips should snap into place.
12. To reassemble the controller, properly orient the chassis with board opening on top. Align the circuit boards into the grooves on the top and bottom of the case. Press firmly on the front face assembly until the chassis is all the way into the case.
If it is difficult to slide the chassis in all the way, make sure the screws have been removed (they can block proper alignment), and that the chassis is properly oriented.
13. Carefully insert and align screws. Tighten them until the bezel is seated firmly against the gasket. **Do not overtighten.**

NOTE: For greatest accuracy, calibrate all milliamp modules added for re-transmission as per the instructions in Appendix 2.

SPECIAL COMMUNICATIONS MODULE

A special communications module is available for the 535; see order code in Chapter 1 for details.

Equipment needed: Wrist grounding strap
 Phillips screwdriver (#2)
 Small flat blade screwdriver

1. Before installing the communications module, set up the hardware wiring for the application. See Chapter 4 for details.
2. With power off, loosen two front screws, and remove them.
3. Slide the chassis out of the case by pulling firmly on the bezel. Do not detach the board assembly from the front face of the controller.
4. Orient the Communications Module as shown, and attach it to Connectors P1 and P2 as shown in Figure 4.4.
5. To reassemble the controller, properly orient the chassis with board opening on top. Align the circuit boards into the grooves on the top and bottom

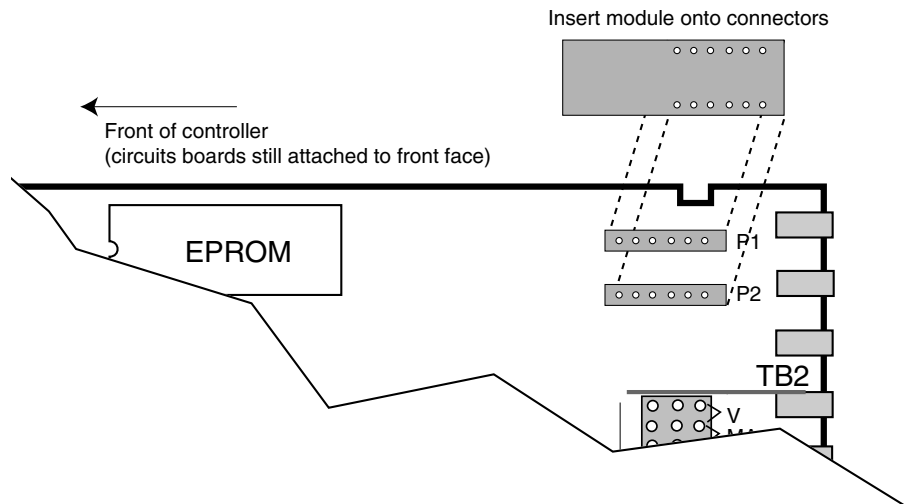

Figure 4.4
Install Communications Module
onto Microcontroller Board

of the case. Press firmly on the front face assembly until the chassis is all the way into the case.

If it is difficult to slide the chassis in all the way, make sure the screws have been removed (they can block proper alignment), and that the chassis is properly oriented.

6. Carefully insert and align screws. Tighten them until the bezel is seated firmly against the gasket. **Do not overtighten.**

CHAPTER 5 SOFTWARE CONFIGURATION

The software configuration menus of the 535 contain user-selected variables that define the action of the controller. Read through this section before making any parameter adjustments to the controller.

Figure 5.1
Menu Flowchart for Set Up

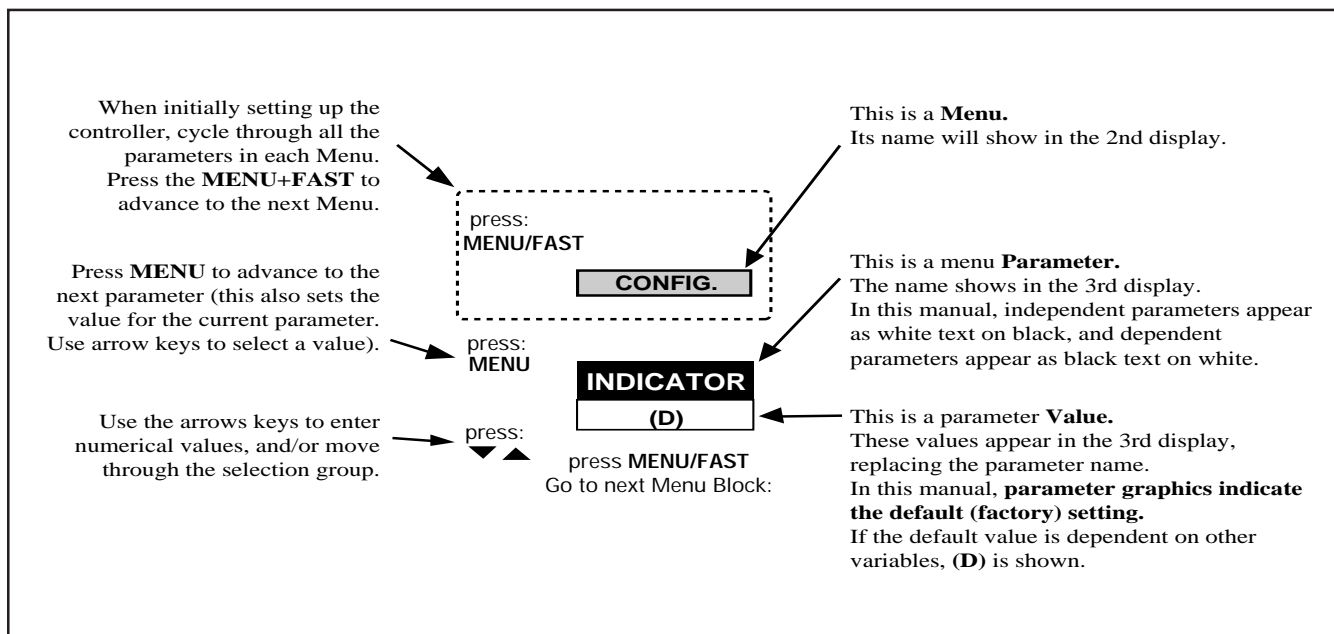

MENUS

In Set Up mode, there are 13 sets of options that control different aspects of 535 operation; in Tuning mode, there is one. Each set of options is called a **menu**. When traversing the two modes, the menu names appear in the 2nd display.

CONFIG Mode selection and input/output hardware assignments

PV1 INPUT 1st process variable input options

PV2 INPUT 2nd process variable input options

CUST. LINR. Linearization curve options for PV1 input.

CONTROL Control options

ALARMS Alarm options

REM. SETPT. Controller remote setpoint options

RETRANS. Retransmission output options

SELF TUNE Self tune algorithm options

SPECIAL Special feature options

SECURITY Security functions

SER.COMM. Serial Communications options (requires comm. board)

and

TUNING Tuning parameters configuration (see Chapter 6)

CAUTION!

All software changes occur in real time; always perform set up functions under manual operation.

NOTE: For information about the Tuning menu/mode, refer to Chapter 6. For more information about set up parameters and 535 applications, refer to Chapter 7.

TUNE PT.
AUTOMATIC

CONTACT 1
MANUAL

PARAMETERS

Within each menu are **parameters** for particular control functions. Select values for each parameter depending on the specific application. Use the MENU key to access parameters for a particular menu; the parameter name will replace the menu name in the 2nd display, and the parameter value will show in the 3rd display.

This chapter outlines **all** the available parameters for the 535. Some parameters are **independent** of any special configuration, and others are **dependent** on the individual configuration. This manual displays these two types of parameters differently; refer to Figure 5.2. A special feature of the 535, called **Smart Menus**, determines the correct parameters to display for the specific configuration, so not all the listed parameters will appear.

Figure 5.2
Independent vs. Dependent
Parameters

Figure 5.3
Configuration Flowchart

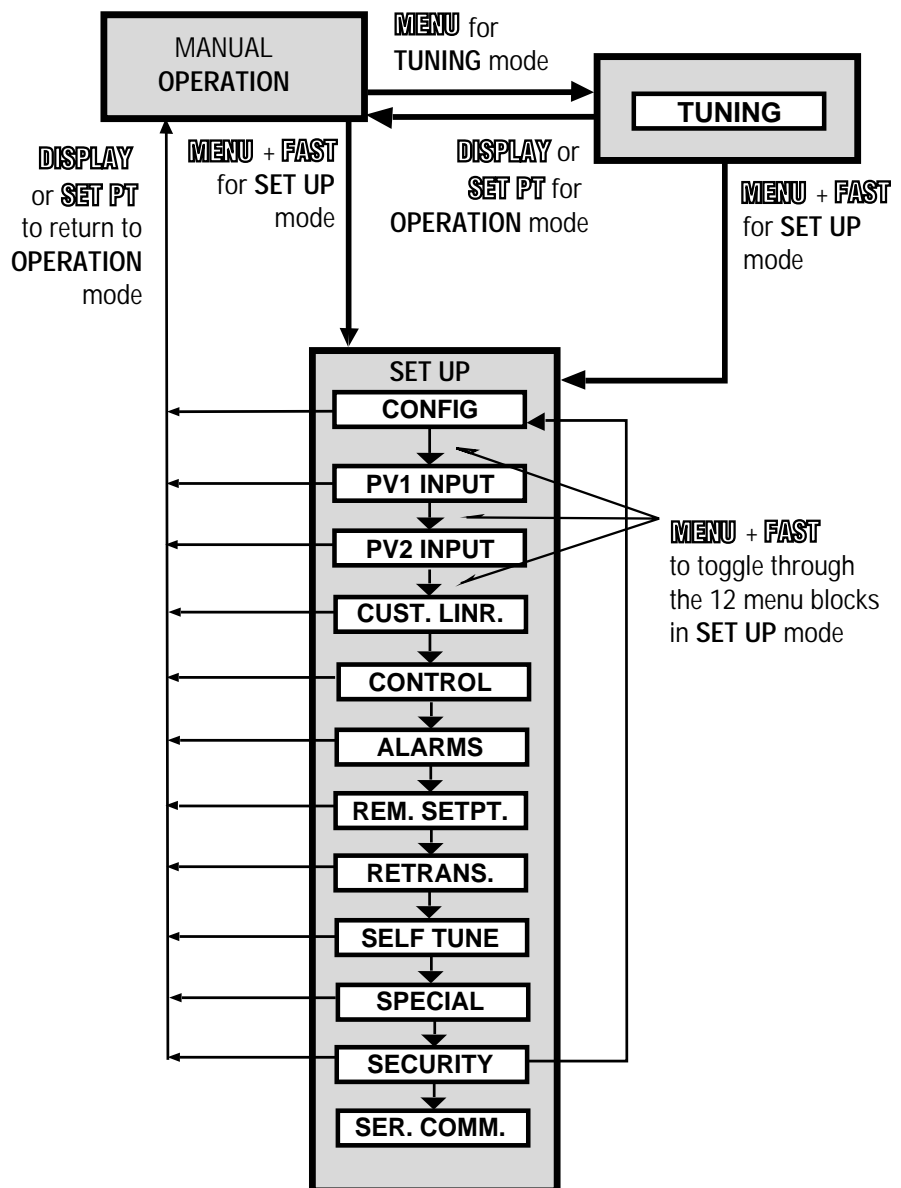

CONFIGURATION AND OPERATION

Figure 5.3 shows the relationships among the different modes of the 535 and the configuration menus:

- **SET UP** menus can only be accessed from manual control. To transfer the 535 from automatic to manual control, press **MANUAL**.
- To access the **SET UP** menus, hold down **FAST** and press **MENU**. The **MENU** key will illuminate; and CONFIG will appear in the 2nd display.
- To access the parameters for a particular menu, press **MENU**.
- To select a parameter value, use **▲** and **▼**. Press **MENU** to advance to the next parameter, or **FAST+MENU** to advance to the next menu.
- To advance to the next menu, press **FAST+MENU**.
- **TUNING** mode (and the **TUNING** menu) can be accessed from either automatic or manual control. To access the tuning menu, press **MENU**.
- To return controller to manual control, press **DISPLAY** or **SET PT**.

A key to these functions (as shown below) appears at the bottom of every page in the menu section of this chapter.

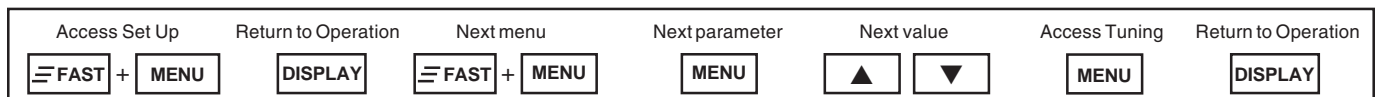

WHERE TO GO NEXT

- For information about all the software menus and parameters, continue reading this chapter. Refer to Appendix D for a quick-reference flowchart of all menus and parameters.
- For information about the installed options on the 535, compare the product label on top of the controller to the order code in Chapter 1.
- To mount the controller and configure the wiring of the 535 for inputs and outputs, see Chapter 3.
- To alter the output module and jumper configuration of the controller, see Chapter 4.
- For more information about applications for the 535, see Chapter 6.
- For more information about the Tuning function of the 535, see Chapter 7.

CONFIG.

CTRL.TYPE

STANDARD

LINE FREQ

60 Hz

PV SOURCE

PV1

NOTE:

PV1 and PV2 can be of different types and different range.

REM. SETPT.

DISABLED

OUTPUT 2

OFF

SOFTWARE MENUS AND PARAMETERS

CONFIG.

1. CTRL.TYPE

Defines the type of control output(s).

- D STANDARD Standard control output, no special algorithms
- POS. PROP. Position proportioning control output
- STAGED Staged outputs
- DUPLEX Duplex outputs

2. LINE FREQ

Defines the power source frequency.

- 50 HZ
- D 60 HZ

3. PV SOURCE

Defines how the PV input is derived from PV1 and PV2.

- D PV1 Use PV1
- 1/2:SWITCH Use PV1 until contact/com selects PV2
- 1/2:BACKUP Use PV2 if PV1 is broken
- PV1–PV2 Use PV1–PV2
- PV1+PV2 Use PV1+PV2
- AVG. PV Use the average of PV1 and PV2
- HI SELECT Use PV1 or PV2 (whichever is greater)
- LO SELECT Use PV1 or PV2 (whichever is less)

4. REM. SETPT.

Selects function of the remote setpoint.

- D DISABLED
- ENABLED

5. OUTPUT 2

Defines the function of the second output.

- ALM.RLY:ON
- ALM.RLY:OFF
- RETRANS. Retransmission
- COMM. ONLY Output addressable through communication
- D OFF Completely deactivates the output

Access Set Up	Return to Operation	Next menu	Next parameter	Next value	Access Tuning	Return to Operation

6. OUTPUT 3

Defines the function of the third output.

- ALM.RLY:ON
- ALM.RLY:OFF
- RETRANS. Retransmission
- COMM. ONLY Output addressable through communications
- D OFF Completely deactivates the output



7. OUTPUT 4

Defines the function of the fourth output.

- ALM.RLY:ON
- ALM.RLY:OFF
- RETRANS. Retransmission
- COMM. ONLY Output addressable through communications
- D OFF Completely deactivates the output



8. ANLG. RNG.:1

Defines the output signal for the first output.

- D 4–20 mA
- 0–20 mA
- 20–4 mA
- 20–0 mA



9. ANLG. RNG.:2

Defines the output signal for the second output.

- D 4–20 mA
- 0–20 mA
- 20–4 mA
- 20–0 mA



10. ANLG. RNG.:3

Defines the output signal for the third output.

- D 4–20 mA
- 0–20 mA
- 20–4 mA
- 20–0 mA



11. ANLG. RNG.:4

Defines the output signal for the fourth output.

- D 4–20 mA
- 0–20 mA
- 20–4 mA
- 20–0 mA



CONTACT 1

MANUAL

12. CONTACT 1

Defines the operation of the first digital input.

- SETPT. 1–8 Assigns the first four digital inputs to select setpoints 1 through 8 via BCD signal
- REM. SETPT. Makes the remote setpoint active
- D** MANUAL Trips the controller to manual control
- 2ND. SETPT. Makes the second setpoint active
- 2ND. PID Makes the second set of PID values active
- ALARM ACK. Acknowledges alarms
- RST. INHBT. Deactivates the reset term
- D.A./R.A. Switches the control action
- STOP A/T Suspends the adaptive tune function
- LOCK. MAN. Locks controller in manual control
- UP KEY Remote ▲ function
- DOWN KEY Remote ▼ function
- DISP KEY Toggle between SP DEV or OUT%
- FAST KEY Activates **FAST** key
- MENU KEY Activates **MENU** key.
- COMM. ONLY Status readable only through communications
- PV2.SWITCH Switches between PV1 and PV2

CONTACT 2

REM.SETPT.

13. CONTACT 2

Defines the operation of the second digital input.

- D** REM. SETPT. Makes the remote setpoint active
- MANUAL Trips the controller to manual control
- 2ND. SETPT. Makes the second setpoint active
- 2ND. PID Makes the second set of PID values active
- ALARM ACK. Acknowledges alarms
- RST. INHBT. Deactivates the reset term
- D.A./R.A. Switches the control action
- STOP A/T Suspends the adaptive tune function
- LOCK. MAN. Locks controller in manual control
- UP KEY Remote ▲ function
- DOWN KEY Remote ▼ function
- DISP KEY Toggle between SP DEV or OUT%
- FAST KEY Activates **FAST** key
- MENU KEY Activates **MENU** key.
- COMM. ONLY Status readable only through communications
- PV2.SWITCH Switches between PV1 and PV2

Access Set Up	Return to Operation	Next menu	Next parameter	Next value	Access Tuning	Return to Operation
+		+				

14. CONTACT 3

Defines the operation of the third digital input.

- REM. SETPT. Makes the remote setpoint active
- MANUAL Trips the controller to manual control
- D** 2ND. SETPT. Makes the second setpoint active
- 2ND. PID Makes the second set of PID values active
- ALARM ACK. Acknowledges alarms
- RST. INHBT. Deactivates the reset term
- D.A./R.A. Switches the control action
- STOP A/T Suspends the adaptive tune function
- LOCK. MAN. Locks controller in manual control
- UP KEY Remote ▲ function
- DOWN KEY Remote ▼ function
- DISP KEY Toggle between SP DEV or OUT%
- FAST KEY Activates **FAST** key
- MENU KEY Activates **MENU** key.
- COMM. ONLY Status readable only through communications
- PV2.SWITCH Switches between PV1 and PV2

CONTACT 3

2ND. SETPT.









15. CONTACT 4

Defines the operation of the fourth digital input.

- REM. SETPT. Makes the remote setpoint active
- MANUAL Trips the controller to manual control
- 2ND. SETPT. Makes the second setpoint active
- D** 2ND. PID Makes the second set of PID values active
- ALARM ACK. Acknowledges alarms
- RST. INHBT. Deactivates the reset term
- D.A./R.A. Switches the control action
- STOP A/T Suspends the adaptive tune function
- LOCK. MAN. Locks controller in manual control
- UP KEY Remote ▲ function
- DOWN KEY Remote ▼ function
- DISP KEY Toggle between SP DEV or OUT%
- FAST KEY Activates **FAST** key
- MENU KEY Activates **MENU** key.
- COMM. ONLY Status readable only through communications
- PV2.SWITCH Switches between PV1 and PV2

CONTACT 4

2ND. PID

Access Set Up	Return to Operation	Next menu	Next parameter	Next value	Access Tuning	Return to Operation
 FAST +  MENU	 DISPLAY	 FAST +  MENU	 MENU	 ▲  ▼	 MENU	 DISPLAY

CONTACT 5 ALARM ACK.

16. CONTACT 5

This defines the operation of the fifth digital input.

- REM. SETPT. Makes the remote setpoint active
- MANUAL Trips the controller to manual control
- 2ND. SETPT. Makes the second setpoint active
- 2ND. PID Makes the second set of PID values active
- D** ALARM ACK. Acknowledges alarms
- RST. INHBT. Deactivates the reset term
- D.A./R.A. Switches the control action
- STOP A/T Suspends the adaptive tune function
- LOCK. MAN. Locks controller in manual control
- UP KEY Remote ▲ function
- DOWN KEY Remote ▼ function
- DISP KEY Toggle between SP DEV or OUT%
- FAST KEY Activates **FAST** key
- MENU KEY Activates **MENU** key.
- COMM. ONLY Status readable only through communications

LOOP NAME LOOP ONE

17. LOOP NAME

A 9-character message associated with the loop. The first character of the 3rd display will be flashing. To enter message, press ▲ and ▼ keys to scroll through character set. Press **FAST** key to enter the selection and move to next digit. Press **MENU** key to advance to next parameter.

D LOOP ONE

PV INPUT

PV1 INPUT

PV1 TYPE

JT/C

1. PV1 TYPE

Specifies the particular sensor range or input range for PV1.

<u>T/C</u>	<u>RTD</u>	<u>VOLTAGE</u>	<u>CURRENT (mA)</u>
D J T/C	D DIN RTD	D 1-5 V	D 4-20mA
• E T/C	• JIS RTD	• 0-5 V	• 0-20mA
• K T/C	• SAMA RTD	• 0-10 mV	
• B T/C		• 0-30 mV	
• N T/C		• 0-60 mV	
• R T/C		• 0-100 mV	
• S T/C		• +/- 25 mV	
• T T/C			
• W T/C			
• W5 T/C			
• PLAT.II T/C			

CAUTION!

Set parameter values in the presented order—dependent parameters are dynamically related and changing values of one can alter the value of another.

For example, if **SP LO LIM.** is set to 0, and then thermocouple type is changed to **B T/C**, the **SP LO LIM.** value will change to 104° (the low limit of a type B thermocouple).

Access Set Up	Return to Operation	Next menu	Next parameter	Next value	Access Tuning	Return to Operation
+		+				

2. DEG. F/C/K

Selects the PV1 temperature units if using a thermocouple or RTD.

D FAHR.

- CELSIUS
- KELVIN

DEG. F/C/K

FAHR

3. DECIMAL

Specifies the PV1 decimal point position.

D XXXXX

- XXXX.X
- XXX.XX
- XX.XXX
- X.XXXX

DECIMAL

XXXXX

4. LINEARIZE

Specifies if the PV1 input is to be linearized. NOTE: T/C's and RTD's are automatically linearized.

D NONE

- SQR. ROOT Square root linearization is activated.
- CUSTOM 15-point custom linearization curve is activated.

LINEARIZE

NONE

5. LOW RANGE

Specifies the engineering unit value corresponding to the lowest PV1 input value, e.g. 4 mA.

R -9999 to 99999 Max. is **HI RANGE**

D Dependent on the input selection

LOW RANGE

(D)

6. HI RANGE

Specifies the engineering unit value corresponding to the highest PV1 input value, e.g., 20mA.

R -9999 to 99999 Min. is **LOW RANGE**

D Dependent on the input selection

HI RANGE

(D)

7. SP LO LIM.

Defines the lowest setpoint value that can be entered from the front panel only.

R -9999 to 99999 Max. is **SP HI LIM.** Min. is **LOW RANGE**

D Dependent on the **LOW RANGE** value.

SP LO LIM.

(D)

8. SP HI LIM.

Defines the highest setpoint value that can be entered from the front panel only.

R -9999 to 99999 Min. is **SP LO. LIM.** Maximum is **HI RANGE**

D Dependent on **HI RANGE**

SP HI LIM.

(D)

Access Set Up	Return to Operation	Next menu	Next parameter	Next value	Access Tuning	Return to Operation
FAST + MENU	DISPLAY	FAST + MENU	MENU		MENU	DISPLAY

Controller Set Up

SP RAMP
OFF

FILTER
0

OFFSET
0

GAIN
1.000

RESTORE
LAST MODE

PV2 INPUT

PV2 SETUP
SAME.AS.PV1

9. SP RAMP

Defines the rate of change for setpoint changes.

D OFF Deactivates this function

R 1 to 99999 units per hour

10. FILTER

Specifies the setting for the low pass PV1 input filter.

R 0 to 120 seconds

D 0 seconds

11. OFFSET

Defines the offset to PV1 in engineering units.

R -9999 to 99999

D 0

12. GAIN

Defines the gain to PV1.

R 0.100 to 10.000

D 1.000

13. RESTORE

Defines the control mode when a broken PV1 signal is restored.

D LAST MODE

- MANUAL
- AUTOMATIC

PV2 INPUT

1. PV2 SETUP

Defines function of PV2

D SAME.AS.PV1

- NOT PV1

All PV2 parameters are set to the same values as PV1 (no further parameters will appear)

Enables user to enter different values for the following PV2 parameters

Access Set Up	Return to Operation	Next menu	Next parameter	Next value	Access Tuning	Return to Operation
FAST + MENU	DISPLAY	FAST + MENU	MENU		MENU	DISPLAY

2. PV2 TYPE

Selects the particular sensor or input range for PV2

<u>T/C</u>	<u>RTD</u>	<u>VOLTAGE</u>	<u>CURRENT (mA)</u>
D J T/C	D DIN RTD	D 1-5 V	D 4-20mA
• E T/C	• JIS RTD	• 0-5 V	• 0-20mA
• K T/C	• SAMA RTD	• 0-10 mV	
• B T/C		• 0-30 mV	
• N T/C		• 0-60 mV	
• R T/C		• 0-100 mV	
• S T/C		• +/- 25 mV	
• T T/C			
• W T/C			
• W5 T/C			
• PLAT.II T/C			

PV2TYPE

J/T/C

3. DECIMAL

Specifies the PV2 decimal point position.

- D** XXXXX
- XXXX.X
 - XXX.XX
 - XX.XXX
 - X.XXXX

DECIMAL

XXXXX

4. LINEARIZE

Specifies if the PV2 input is to be linearized. Thermocouples and RTD's are automatically linearized.

- D** NONE
- SQR. ROOT Square root linearization is activated.

LINEARIZE

NONE

5. LOW RANGE

Specifies the engineering unit value corresponding to the lowest PV2 input value, e.g. 4 mA.

- R** -9999 to 99999 Max. is HI RANGE
- D** Dependent on the input selection

LOW RANGE

(D)

6. HI RANGE

Specifies the engineering unit value corresponding to the highest PV2 input value, e.g. 20 mA.

- R** -9999 to 99999 Min. is LOW RANGE
- D** Dependent on the input selection

HI RANGE

(D)

7. FILTER

Setting for the low pass PV2 input filter.

- R** 0 to 120 seconds
- D** 0 seconds

FILTER

0

Access Set Up	Return to Operation	Next menu	Next parameter	Next value	Access Tuning	Return to Operation
FAST + MENU	DISPLAY	FAST + MENU	MENU		MENU	DISPLAY

Controller Set Up

OFFSET

0

GAIN

1.000

RESTORE

LAST MODE

CUST. LINR.

1ST. INPUT

(D)

1ST. PV

0

XTH INPUT

(D)

XTH PV

0

8. OFFSET

Defines the offset to PV2 in engineering units.

R -9999 to 99999

D 0

9. GAIN

Defines the gain for PV2.

R 0.100 to 10.000

D 1.000

10. RESTORE

Defines the control mode when a broken PV2 signal is restored.

D LAST MODE

- MANUAL
- AUTOMATIC

CUST. LINR.

Defines a custom linearization curve for PV1, if selected. Points 1 and 15 are fixed to the low and high end of the input range and require only setting a corresponding PV value. Points 2 through 14 (the Xth points) require setting both the input and PV values.

It is not necessary to use all 15 points. Whenever the **XTH INPUT** becomes the high end of the range, that will be the last point in the linearization table.

1. 1ST. INPUT

Specifies the input signal corresponding to the first point.

D The low end of the appropriate input range (e.g. 4.00 mA)

2. 1ST. PV

Specifies the engineering unit value corresponding to the first point.

R -9999 to 99999

D 0

3. XTH. INPUT

Specifies the input signal corresponding to the XTH point (X is 2 to 14).

R Any value greater than the first input

D The low end of the appropriate input range (e.g. 4.00 mA)

4. XTH. PV

Specifies the unit value corresponding to the XTH point (X is 2 to 14).

R -9999 to 99999

D 0

Access Set Up

 FAST + MENU

Return to Operation

DISPLAY

Next menu

 FAST + MENU

Next parameter

MENU

Next value

Access Tuning

MENU

Return to Operation

DISPLAY

5. 15TH. INPT.

Specifies the input signal corresponding to the 15th point.

R -9999 to 99999 Minimum is [XTH-1] INPUT

D The high end of the appropriate input range (e.g. 20.00 mA)

15TH INPT.

(D)

6. 15TH. PV

Specifies the engineering unit value corresponding to the 15th point.

R -9999 to 99999

D 0

15TH PV

0

CONTROL

For configuring the choices for the control algorithm.

1. ALGORITHM

Defines the type of control algorithm.

D PID

- PI
- PD
- P
- ON/OFF
- PID:ON/OFF For Duplex applications using PID for the first output and on/off for the second output

ALGORITHM

PID

2. D. SOURCE

Selects the variable for the derivative action.

D PV Derivative term will not react when setpoint changes

- DEVIATION Derivative term will react when setpoint changes

D. SOURCE

PV

3. ACTION:1

Defines the action of the first control output.

- DIRECT

D REVERSE

ACTION:1

REVERSE

4. PV BREAK

Defines the manual output level if the process variable input is lost. Choose values based on the process type.

Standard Control

On/Off Control

Velocity Prop Control

- -5 to 105%

- ON

- CW

D 0

D OFF

- CCW

D OUTS. OFF

PV BREAK

(D)

5. LOW OUT.

Defines the lowest output value that can be achieved in automatic control.

R 0-100%

Max is HIGH OUT

D 0%

LOW OUT

0

Access Set Up	Return to Operation	Next menu	Next parameter	Next value	Access Tuning	Return to Operation
FAST + MENU	DISPLAY	FAST + MENU	MENU	▲ ▼	MENU	DISPLAY

Controller Set Up

HIGH OUT.

100

ACTION:2

DIRECT

P.P. TYPE

(D)

CCW TIME

60

CW TIME

60

MIN. TIME

0.1

S/W RANGE

100

OPEN F/B

(D)

6. HIGH OUT.

Defines the highest output value that can be achieved in automatic control.

R 0–100%

Min is LOW OUT

D 100%

7. ACTION:2

Defines the action of the second control output.

D DIRECT

- REVERSE

8. P.P. TYPE

Defines the type of position proportioning algorithm. Choose values based on the process.

Feedback option installed

D SLIDEWIRE

- VELOCITY

Feedback option not installed

- SLIDEWIRE

D VELOCITY

9. CCW TIME

Defines the time it takes a motor to fully stroke counter clockwise.

R 1 to 200 seconds

D 60 seconds

10. CW TIME

Defines the time it takes a motor to fully stroke clockwise .

R 1 to 200 seconds

D 60 seconds

11. MIN. TIME

Defines the minimum amount of time the controller must specify for the motor to be on before it takes action.

R 0.1 to 10.0 seconds

D 0.1 seconds

12. S/W RANGE

Specifies the full range resistance of the slide (e.g., 100 ohms)

R 0–1050 Ohms

D 100 Ohms

13. OPEN F/B

Defines the feedback ohm value corresponding to full open (100% output).

R 0 to S/W RANGE

D Dependent on S/W RANGE value

Access Set Up

Return to Operation



Next menu

Next parameter



Next value

Access Tuning

Return to Operation

 + 



 + 







14. CLOSE F/B

Defines the feedback ohm value corresponding to full close (0% output).

R 0 to S/W RANGE

D 100 Ohms

CLOSE F/B

100

15. OUT1 STOP

This defines the stopping point for control output 1 when staging outputs.

R 1 to 100%

D 50%

OUT1 STOP

50

16. OUT2 STRT.

Defines the starting point for control output 2 when staging outputs.

R 0 to 99%

D 50%

OUT2 STRT.

50

ALARMS

ALARMS

1. ALM. TYPE:1

Defines the type of alarm for alarm 1.

- HIGH ALRM.
- LOW ALARM
- HIGH/LOW

Separate High & Low alarm setpoints in one alarm

- BAND
- DEVIATION
- MANUAL
- REMOTE SP

Causes an alarm when in manual control

Causes an alarm when in Remote Setpoint

- RATE

Selects a rate-of-change alarm

D OFF

Deactivates the first alarm

ALM. TYPE:1

OFF

2. ALM. SRC:1

Selects the source of the value being monitored by HIGH, LOW or HIGH/LOW alarm 1.

- D PV
- SP
- RAMP SP
- DEVIATION
- OUTPUT
- PV2

ALM. SRC:1

PV

Access Set Up	Return to Operation	Next menu	Next parameter	Next value	Access Tuning	Return to Operation

ALARM SP:1

0.0%

HIGH SP:1

0.0%

LOW SP:1

0.0%

DEADBAND:1

2

ALM.:1 OUT

NONE

LATCHING:1

NONE

3. ALARM SP:1

Specifies the alarm set point for alarm 1 (except HIGH/LOW)

For HIGH or LOW alarms:

If **ALM.SRC.:1** = OUTPUT

R 0.0% to 100.0%

D 0.0%

For **BAND** alarms:

R 1 to 99999

D 0

For **DEVIATION** or **RATE** alarms:

R -9999 to 99999

D 0

If **ALM.SRC.:1** = any other type

R LOW RANGE to HI RANGE

D 0

4A. HIGH SP:1

Specifies the high alarm set point for alarm 1 of type HIGH/LOW.

If **ALM.SRC.:1** = OUTPUT

R 0.0% to 100.0%

D 0.0%

If **ALM.SRC.:1** = any other type

R LOW RANGE to HI RANGE

D 0

4B. LOW SP:1

Specifies the low alarm set point for alarm 1 of type HIGH/LOW.

If **ALM.SRC.:1** = OUTPUT

R 0.0% to 100.0%

D 0.0%

If **ALM.SRC.:1** = any other type

R LOW RANGE to HI RANGE

D 0

5. DEADBAND:1

Defines the deadband for alarm 1.

If **ALM.SRC.:1** = OUTPUT

R 0.1% to 100.0%

D 2

If **ALM.SRC.:1** = any other type

R 1 to 99999

D 2

6. ALM.:1 OUT.

Selects the output number for alarm 1.

D NONE

- 2
- 3
- 4

7. LATCHING:1

Defines the latching sequence of alarm 1.

D LATCH

- NOLATCH

Access Set Up	Return to Operation	Next menu	Next parameter	Next value	Access Tuning	Return to Operation
+		+				

8. ACK.:1

Defines whether alarm 1 may be acknowledged.

- D ENABLED Allows the alarm to be acknowledged
- DISABLED Prevents the alarm from being acknowledged while in alarm condition

ACK.:1
ENABLED

9. POWER UP:1

Defines how alarm 1 will be treated on power up.

- D NORMAL Alarm depends on process variable
- ALARM Always power up in alarm regardless of PV
- DELAYED Must leave alarm condition and reenter before activating the alarm

POWER UP:1
NORMAL

10. MESSAGE:1

A 9-character message associated with alarm 1. To enter message: The first character of third display will be flashing. Press the ▲ and ▼ keys to scroll through the character set. Press **FAST** key to advance to subsequent characters. Press the **MENU** to advance to next parameter.

- D ALARM 1.

MESSAGE:1
ALARM 1

11. ALM. TYPE:2

Defines the type of alarm for alarm 2.

- HIGH ALRM.
- LOW ALARM
- HIGH/LOW Separate High & Low alarm setpoints in one alarm
- BAND
- DEVIATION
- MANUAL Causes an alarm when in manual control
- REMOTE SP Causes an alarm when in Remote Setpoint
- RATE Selects a rate-of-change alarm
- D OFF Deactivates the first alarm

ALM. TYPE:2
OFF

12. ALM. SRC.:2

Selects the source of the value being monitored by HIGH, LOW or HIGH/LOW alarm 2.

- D PV
- SP
- RAMP SP
- DEVIATION
- OUTPUT
- PV2

ALM.SRC.:2
PV



ALARM SP:2

(D)

13. ALARM SP:2

Specifies the alarm set point for alarm 2 (except HIGH/LOW)

For HIGH or LOW alarms:

If **ALM.SRC.:2** = OUTPUT

R 0.0% to 100.0%

D 0.0%

For **BAND** alarms:

R 1 to 99999

D 0

For **DEVIATION** or **RATE** alarms:

R -9999 to 99999

D 0

If **ALM.SRC.:2** = any other type

R **LOW RANGE** to **HI RANGE**

D 0

HIGH SP:2

0.0%

14A. HIGH SP:2

Specifies the high alarm set point for alarm 2 of type HIGH/LOW.

If **ALM.SRC.:2** = OUTPUT

R 0.0% to 100.0%

D 0.0%

If **ALM.SRC.:2** = any other type

R **LOW RANGE** to **HI RANGE**

D 0

LOW SP:2

0.0%

14B. LOW SP:2

Specifies the low alarm set point for alarm 2 of type HIGH/LOW.

If **ALM.SRC.:2** = OUTPUT

R 0.0% to 100.0%

D 0.0%

If **ALM.SRC.:2** = any other type

R **LOW RANGE** to **HI RANGE**

D 0

DEADBAND:2

2

15. DEADBAND:2

Defines the deadband for alarm 2.

If **ALM.SRC.:2** = OUTPUT

R 0.1% to 100.0%

D 2

If **ALM.SRC.:2** = any other type

R 1 to 99999

D 2

ALM.:2 OUT.

NONE

16. ALM.:2 OUT.

Selects the output number for alarm 2.

D NONE

- 2
- 3
- 4

LATCHING:2

LATCH

17. LATCHING:2

Defines the latching sequence of alarm 2.

D LATCH

- NO LATCH

Access Set Up	Return to Operation	Next menu	Next parameter	Next value	Access Tuning	Return to Operation
FAST + MENU	DISPLAY	FAST + MENU	MENU	▲ ▼	MENU	DISPLAY

18. ACK.:2

Defines whether alarm 2 may be acknowledged.

- D** ENABLED Allows the alarm to be acknowledged
- DISABLED Prevents the alarm from being acknowledged while in alarm condition



19. POWER UP:2

Defines how alarm 2 will be treated on power up.

- D** NORMAL Alarm depends on process variable
- ALARM Always power up in alarm regardless of process variable
- DELAYED Must leave alarm condition and reenter before activating the alarm



20. MESSAGE:2

A 9-character message associated with alarm 2. To enter message: The first character of third display will be flashing. Press the ▲ and ▼ keys to scroll through the character set. Press **FAST** key to advance to subsequent characters. Press **MENU** to advance to next parameter.

- D** ALARM 2.



21. FAULT

Defines whether either of the alarm relays will trip if a fault condition (lost process variable) is detected. Only appears if at least one alarm relay is installed.

- D** OFF
- ALARM 1
- ALARM 2



22. OUTPUT

Defines whether a rate-of-change alarm is interpreted as a lost or broken process variable (causing a trip to manual output).

- P.V. BREAK
- D** NO ACTION



23. RATE TIME

Defines the time period over which a rate-of-change alarm condition is determined.

- R** 1 to 3600 seconds
- D** 5 seconds

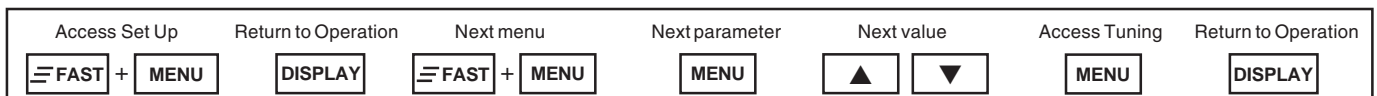

Controller Set Up

REM. SETPT.

RSP.TYPE
1-5 4-20

RSP:LO RNG.
0

RSP:HI RNG.
1000

RSP:LOW
(D)

RSP:HIGH
(D)

TRACKING
NO

BIAS LOW
-1000

BIAS HIGH
1000

REM. SETPT.

This menu appears only if parameter **REM. SETPT** (of the **CONFIG.** menu) = **ENABLED**.

- TYPE V/mA**
Specifies the type of input signal that will be used for remote setpoint.
D 1-5/4-20 1–5 volt or 4–20 mA remote setpoint
• 0-5/0-20 0–5 volt or 0–20 mA remote setpoint
- RSP:LO RNG.**
Specifies the engineering unit value corresponding to the lowest remote setpoint input value, e.g. 4 mA.
R -9999 to 99999
D 0
- RSP:HI RNG.**
Specifies the engineering unit value corresponding to the highest remote setpoint input value, e.g. 20 mA.
R -9999 to 99999
D 1000
- RSP: LOW**
Defines the lowest setpoint value to be accepted from the remote setpoint source.
R -9999 to 99999.
D Dependent on RSP:LO.RNG. value.
- RSP: HIGH**
Defines the highest setpoint value from a remote setpoint source.
R -9999 to 99999
D Dependent on RSP:HI.RNG. value
- TRACKING**
Defines whether the local setpoints 1 to 8 will track the remote setpoint.
D NO
• YES
- BIAS LOW**
Defines the lowest bias value that may be entered.
R -9999 to 99999. Maximum value is **BIAS HIGH**.
D -1000
- BIAS HIGH**
Defines the highest bias value that may be entered.
R -9999 to 99999. Minimum value is **BIAS LOW**.
D 1000

Access Set Up	Return to Operation	Next menu	Next parameter	Next value	Access Tuning	Return to Operation
+		+				

9. RSP FIXED

Defines what happens if remote setpoint is lost while it is active and then is restored.

- REMOTE SP Returns to remote setpoint when it is restored
- D LOCAL Local setpoint remains active when RSP is restored

RSP: FIXED

LOCAL

RETRANS.

RETRANS.

1. TYPE:2

Defines what is to be retransmitted for output 2

- D PV This refers to the linearized process variable
- SETPOINT This is the target setpoint
- RAMP SP This is the ramping, or actual setpoint, when the setpoint is ramping
- CTRL. OUT This is the control output value

TYPE:2

PV

2. LOW RANGE:2

Defines the low end of the range for output 2 in engineering units. Does not appear for type **CTRL.OUT**.

- R -9999 to 99999
- D Dependent on the process variable range

LO RANGE:2

(D)

3. HI RANGE:2

Defines the high end of the range for output 2 in engineering units. Does not appear for type **CTRL.OUT**.

- R -9999 to 99999
- D Dependent on the process variable range

HI RANGE:2

(D)

4. TYPE:3

Defines what is to be retransmitted for output 3

- D PV This refers to the linearized process variable
- SETPOINT This is the target setpoint
- RAMP SP This is the ramping, or actual setpoint, when the setpoint is ramping
- CTRL. OUT This is the control output value

TYPE:3

PV

5. LOW RANGE:3

Defines the low end of the range for output 3 in engineering units. Does not appear for type **CTRL.OUT**.

- R -9999 to 99999
- D Dependent on the process variable range

LO RANGE:3

(D)

Access Set Up	Return to Operation	Next menu	Next parameter	Next value	Access Tuning	Return to Operation
FAST + MENU	DISPLAY	FAST + MENU	MENU		MENU	DISPLAY

Controller Set Up

HI RANGE:3

(D)

TYPE:4

PV

LO RANGE:4

(D)

HI RANGE:4

(D)

SELFTUNE

TYPE

DISABLED

PRETUNE

TYPE 1

TUNE PT.

AUTOMATIC

6. HI RANGE:3

Defines the high end of the range for output 3 in engineering units. Does not appear for type **CTRL.OUT**.

R -9999 to 99999

D Dependent on the process variable range

7. TYPE:4

Defines what is to be retransmitted for output 4

D PV This refers to the linearized process variable

- SETPOINT This is the target setpoint

- RAMP SP This is the ramping, or actual setpoint, when the setpoint is ramping

- CTRL. OUT This is the control output value

8. LOW RANGE:4

Defines the low end of the range for output 4 in engineering units. Does not appear for type **CTRL.OUT**.

R -9999 to 99999

D Dependent on the process variable range

9. HI RANGE:4

Defines the high end of the range for output 4 in engineering units. Does not appear for type **CTRL.OUT**.

R -9999 to 99999

D Dependent on the process variable range

SELFTUNE

1. TYPE

Defines the type of self tuning algorithm that is available.

- PRETUNE Allows the operator to initiate Pretune only
- ADAPTIVE Allows the operator to initiate Adaptive Tune only
- BOTH Allows the operator to initiate both Pretune and Adaptive Tune

D DISABLED Both Pretune and Adaptive Tune are disabled

2. PRETUNE

Defines the type of pretune algorithm that is available.

D TYPE 1 Normally used with slower thermal processes

- TYPE 2 Normally used with faster fluid or pressure processes

- TYPE 3 Normally used with level control applications

3. TUNE PT.

Defines the PV value at which the output will switch off during a **TYPE 1** pretune. Helps prevent overshoot.

R Any value in PV input range

D AUTOMATIC (Controller defines this point, low end for Automatic)

Access Set Up

Return to Operation



Next menu

Next parameter



Next value

Access Tuning

Return to Operation

 + 



 + 







4. OUT. STEP

Defines the output step size in absolute percent during a **TYPE 2** or **TYPE 3** pretune.

R -50% to 50.0%

D 10.0%

OUT.STEP

10.0

5. LOW LIMIT

Defines the lower most limit the process variable can reach during pretune before aborting.

R Any value in the process variable range

D Dependent on the process variable range

LOW LIMIT

(D)

6. HI LIMIT

Defines the upper most limit the process variable can reach during pretune before aborting.

R Any value in the process variable range

D Dependent on the process variable range

HI LIMIT

(D)

7. TIMEOUT

This defines the execution time limit for pretune before aborting.

R 8 to 1500 minutes

D 1500 minutes

TIMEOUT

1500

8. MODE

Defines the control mode after pretune is completed or aborted.

• **MANUAL**

D **AUTOMATIC**

MODE

AUTOMATIC

9. NOISE BND.

Defines the noise band to be used by the adaptive tuning algorithm.

R 0.1% to 10% of the process variable range

D 0.2%

NOISE BND.

0.2

10. RESP. TIME

Defines response time to be used by the adaptive tuning algorithm.

R 10 to 32000 seconds

D 7200 seconds

RESP. TIME

60

11. DEAD TIME

Defines the amount of time required for process to begin to respond to an output change (used by **POWERBACK** algorithm).

R 0.1 seconds to 7200.0 seconds

D 0.1 seconds

DEAD TIME

0.1

Access Set Up	Return to Operation	Next menu	Next parameter	Next value	Access Tuning	Return to Operation

SPECIAL

AUTO. TRIP

OFF

TRIP DEV.

(D)

DES. OUTPT.

(D)

POWER UP

LAST MODE

PWR. UP:OUT.

(D)

SPECIAL

1. AUTO. TRIP

Defines the condition under which the 535 will automatically trip to automatic control from manual control upon start up.

- D** OFF Deactivates this function
- RISING PV Will trip when a rising process variable is within the specified deviation from the setpoint
 - FALLNG. PV Will trip when a falling process variable is within the specified deviation from the setpoint

2. TRIP DEV.

Defines the deviation from setpoint at which the controller will trip to automatic.

For **AUTO. TRIP = RISING PV** For **AUTO. TRIP = FALLING PV**

- R** -99999 to 0 **R** 0 to 99999
D 0 **D** 0

3. DES. OUTPT.

If a digital input is defined to trip the controller to manual mode, this designates the output value after the trip. LAST OUT means that the output value will be equal to the last output value while in automatic. Choose values based on the process.

- | <u>Standard Control</u> | <u>On/Off Control</u> | <u>Velocity Prop Control</u> |
|-------------------------|-----------------------|------------------------------|
| • -5 to 105% | • ON | • CW |
| D LAST OUT | D OFF | • CCW |
| | | D OUTS. OFF |

4. POWER UP

Defines the control mode upon power up.

- D** LASTMODE Will power up in the same mode prior to power down
- PRETUNE Will Pretune on every power up. (Recommended for TYPE 1 pretune only.)
 - MANUAL
 - AUTOMATIC

5. PWR. UP:OUT.

Defines the output of the controller if powering up in manual mode. "LAST OUT" means that the output value will be equal to the last output value while in automatic. Choose values based on the process.

- | <u>Standard Control</u> | <u>On/Off Control</u> | <u>Velocity Prop Control</u> |
|-------------------------|-----------------------|------------------------------|
| • -5 to 105% | • ON | • CW |
| D LAST OUT | D OFF | • CCW |
| | | D OUTS. OFF |

Access Set Up ≡ FAST + MENU	Return to Operation DISPLAY	Next menu ≡ FAST + MENU	Next parameter MENU	Next value ▲ ▼	Access Tuning MENU	Return to Operation DISPLAY
--------------------------------	--------------------------------	----------------------------	------------------------	-------------------	-----------------------	--------------------------------

6. PWR. UP:SP

Defines the setpoint upon power up.

- D** LAST SP Powers up with the same setpoint (local or remote) that was active prior to power down
- LOCAL Powers up using primary local setpoint
 - REMOTE Powers up using remote setpoint, if available

PWR. UP:SP
LAST SP

7. NO. OF SP

Defines the number of local setpoints (up to 8) to be stored for selection by BCD (binary coded decimal), digital inputs, or front **SET PT** key.

- R** 1 through 8
D 1

NO. OF SP
1

SECURITY

For configuring the security function.

1. SEC. CODE

Defines the security code temporarily unlocking the instrument.

- R** -9999 to 99999
D 0

SECURITY
SEC. CODE
0

2. SP ADJUST

Defines lockout status setpoint changes.

- D** UNLOCKED
• LOCKED

SP ADJUST
UNLOCKED

3. AUTO./MAN.

Defines lockout status of the **MANUAL** key.

- D** UNLOCKED
• LOCKED

AUTO./MAN.
UNLOCKED

4. SP SELECT

Defines lockout status of the **SET PT** key.

- D** UNLOCKED
• LOCKED

SP SELECT
UNLOCKED

5. ALARM ACK.

Defines lockout status of the **ACK** key.

- D** UNLOCKED
• LOCKED

ALARM ACK
UNLOCKED

6. TUNING

Defines lockout status of the tuning parameters.

- D** UNLOCKED
• LOCKED

TUNING
UNLOCKED

Access Set Up	Return to Operation	Next menu	Next parameter	Next value	Access Tuning	Return to Operation
FAST + MENU	DISPLAY	FAST + MENU	MENU		MENU	DISPLAY

Controller Set Up

CONFIGURE

UNLOCKED

SER. COMM.

STATION

1

BAUD RATE

9600

CRC

YES

SHED TIME

OFF

SHED MODE

LAST MODE

SHED OUT.

(D)

7. CONFIGURE

Defines lockout status of the configuration parameters.

- D UNLOCKED
- LOCKED

SER. COMM.

1. STATION

Defines the unit's station address.

- R 1 to 99
- OFF Disables the communications function
- D 1

2. BAUD RATE

Defines the baud rate.

- 1200 BPS
- 2400 BPS
- 4800 BPS
- D 9600 BPS
- 19200 BPS

3. CRC

Defines whether CRC (cyclic redundancy check) is being calculated.

- D YES
- NO

4. SHED TIME

Defines the time interval between communications activity before the controller determines that communications is lost ("sheds").

- R 1 to 512 seconds
- D OFF

5. SHED MODE

Defines the state of the controller if communications is lost ("sheds").

- D LAST MODE Remain in automatic or manual control (last mode before losing communications)
- MANUAL Trip to manual control
- AUTOMATIC Trip to automatic control

6. SHED OUT.

Defines the output if the unit sheds and trips to manual control. Choose values based on the process.

- | <u>Standard Control</u> | <u>On/Off Control</u> | <u>Velocity Prop Control</u> |
|-------------------------|-----------------------|------------------------------|
| • -5 to 105% | • ON | • CW |
| D LAST OUT | D OFF | • CCW |
| | | D OUTS. OFF |

Access Set Up

Return to Operation

Next menu

Next parameter

Next value

Access Tuning

Return to Operation

+ **MENU**

DISPLAY

+ **MENU**

MENU

MENU

DISPLAY

7. SHED SP

Defines the setpoint status if communications is lost.

- D** LAST SP Continues to use setpoint that was active prior to losing communications
- DESIG. SP Goes to a designated setpoint value if communications is lost.



8. DESIG. SP

Defines the value of the designated setpoint if communications is lost.

- R** Any value in the process variable range
- D** Dependent on the process variable range

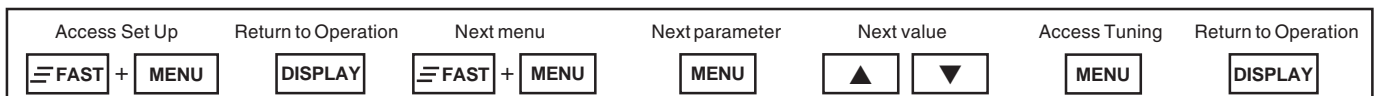

PARAMETER VALUE CHARTS

This section of value charts is provided for logging in the actual parameter values and selections for the process. It is recommended that these pages be photocopied so there will always be a master.

CONFIG

Parameter	Description	Values
1. CTRL. TYPE	Defines fundamental controller Set Up	
2. LINE FREQ.	Defines the power source frequency	
3. PV SOURCE	Defines how PV input is derived from PV1 and PV2	
4. REM. SETPT.	Selects function of the remote setpoint	
5. OUTPUT 2	Function of the second output	
6. OUTPUT 3	Function of the third output	
7. OUTPUT 4	Function of the fourth output	
8. ANLG.RNG.:1	Output signal for the first output	
9. ANLG.RNG.:2	Output signal for the second output	
10. ANLG.RNG.:3	Output signal for the third output	
11. ANLG.RNG.:4	Output signal for the fourth output	
12. CONTACT 1	Operation of the first digital input	
13. CONTACT 2	Operation of the second digital input	
14. CONTACT 3	Operation of the third digital input	
15. CONTACT 4	Operation of the fourth digital input	
16. CONTACT 5	Operation of the fifth digital input	
17. LOOP NAME	Nine character message associated with control loop	

PV1 INPUT

Parameter	Description	Value
1 PV1 TYPE	PV1 sensor or range to be used	
2 DEG. F/C/K	PV1 temperature engineering unit	
3 DECIMAL	PV1 decimal point position	
4 LINEARIZE	Type of PV1 input linearization	
5 LOW RANGE	Engineering unit value for lowest PV1 input value	
6 HI RANGE	Engineering unit value for highest PV1 input value	
7 SP LO LIM.	Lowest setpoint value that can be entered	
8 SP HI LIM.	Highest setpoint value that can be entered	
9 SP RAMP	Rate of change for setpoint changes	
10 FILTER	Setting for the low pass PV1 input filter (in seconds)	
11 OFFSET	Offset to PV1 in engineering units	
12 GAIN	Gain to PV1	
13 RESTORE	Control mode when a broken PV1 is restored	

PV2 INPUT

Parameter	Description	Value
1 PV2 SETUP	Makes PV2 input parameters match PV1, or user definable.	
2 PV2 TYPE	PV2 sensor or range to be used	
3 DECIMAL	PV2 decimal point position	
4 LINEARIZE	Type of PV2 input linearization	
5 LOW RANGE	Engineering unit value for lowest PV2 input value	
6 HI RANGE	Engineering unit value for highest PV2 input value	
7 FILTER	Setting for the low pass PV2 input filter (in seconds)	
8 OFFSET	Offset to the PV2 in engineering units	
9 GAIN	Gain to PV2	
10 RESTORE	Control mode when a broken PV2 is restored	

ALARMS

Parameter	Description	Value
1 ALM. TYPE:1	Type of alarm for alarm 1	
2 ALM. SRC.:1	Source of value monitored by HIGH, LOW or HIGH/LOW alarm 1	
3 ALARM SP:1	Alarm setpoint for alarm 1 (except for HIGH/LOW)	
4A HIGH SP:1	High alarm setpoint for HIGH/LOW alarm 1	
4A LOW SP:1	Low alarm setpoint for HIGH/LOW alarm 1	
5 DEADBAND:1	Deadband for alarm 1	
6 ALM.:1 OUT.	Output number for alarm 1	
7 LATCHING:1	Latching sequence for alarm 1	
8 ACK.:1	Whether alarm 1 may be acknowledged	
9 POWER UP:1	How alarm 1 will be treated upon power up	
10 MESSAGE:1	Nine character message associated with alarm 1	
11 ALM. TYPE:2	Type of alarm for alarm 2	
12 ALM. SRC.:2	Source of value monitored by HIGH, LOW or HIGH/LOW alarm 2	
13 ALARM SP:2	Alarm setpoint for alarm 2 (except for HIGH/LOW)	
14A HIGH SP:2	High alarm setpoint for HIGH/LOW alarm 2	
14B LOW SP:2	Low alarm setpoint for HIGH/LOW alarm 2	
15 DEADBAND :2	Deadband for alarm 2	
16 ALM.:2 OUT.	Output number for alarm 2	
17 LATCHING :2	Latching sequence for alarm 2	
18 ACK.:2	Whether alarm 2 may be acknowledged	
19 POWER UP:2	How alarm 2 will be treated upon power up	
20 MESSAGE:2	Nine character message associated with alarm 2	
21 FAULT	Alarm relay status if fault condition is detected	
22 OUTPUT	Output if the rate-of-change alarm is tripped	
23 RATE TIME	Time period over which a rate-of-change alarm is determined	

CUST. LINR.

Parameter	Description	Value
1 1st INPUT	Input signal for the 1st point (of the 15 point curve)	
2 1st PV	Engineering unit value for the 1st point	
3 Xth INPUT	Input signal for the Xth Point (of the 15 point curve)	
4 Xth PV	Engineering unit value for the Xth point	
5 2nd INPUT	Input signal for the 2nd point (of the 15 point curve)	
6 2nd PV	Engineering unit value for the 2nd point	
7 3rd INPUT	Input signal for the 3rd point (of the 15 point curve)	
8 3rd PV	Engineering unit value for the 3rd point	
9 4th INPUT	Input signal for the 4th point (of the 15 point curve)	
10 4th PV	Engineering unit value for the 4th point	
11 5th INPUT	Input signal for the 5th point (of the 15 point curve)	
12 5th PV	Engineering unit value for the 5th point	
13 6th INPUT	Input signal for the 6th point (of the 15 point curve)	
14 6th PV	Engineering unit value for the 6th point	
15 7th INPUT	Input signal for the 7th point (of the 15 point curve)	
16 7th PV	Engineering unit value for the 7th point	
17 8th INPUT	Input signal for the 8th point (of the 15 point curve)	
18 8th PV	Engineering unit value for the 8th point	
19 9th INPUT	Input signal for the 9th point (of the 15 point curve)	
20 9th PV	Engineering unit value for the 9th point	
21 10th INPUT	Input signal for the 10th point (of the 15 point curve)	
22 10th PV	Engineering unit value for the 10th point	
23 11th INPUT	Input signal for the 11th point (of the 15 point curve)	
24 11th PV	Engineering unit value for the 11th point	
25 12th INPUT	Input signal for the 12th point (of the 15 point curve)	
26 12th PV	Engineering unit value for the 12th point	
27 13th INPUT	Input signal for the 13th point (of the 15 point curve)	
28 13th PV	Engineering unit value for the 13th point	
29 14th INPUT	Input signal for the 14th point (of the 15 point curve)	
30 14th PV	Engineering unit value for the 14th point	
31 15th INPUT	Input signal for the 15th point (of the 15 point curve)	
32 15th PV	Engineering unit value for the 15th point	

CONTROL

Parameter	Description	Value
1 ALGORITHM	Control algorithm used	
2 D. SOURCE	Variable used to determine the derivative value	
3 ACTION:1	Action of the first control output	
4 PV BREAK	Output level if the process variable input is lost	
5 LOW OUT.	Lowest output value that can be achieved in automatic control	
6 HIGH OUT.	Highest output value that can be achieved in automatic control	
7 ACTION:2	Action of the second control output	
8 P.P. TYPE	Type of position proportioning algorithm	
9 CCW TIME	Time it takes a motor to fully stroke in the CCW direction	
10 CW TIME	Time it takes a motor to fully stroke in the CW direction	
11 MIN. TIME	Minimum time for the motor to be on before taking action	
12 S/W RANGE	Full range resistance of the slidewire	
13 OPEN F/B	Feedback ohm value when the valve is open	
14 CLOSE F/B	Feedback ohm value when the valve is closed	
15 OUT1 STOP	Stopping point for control output 1 when staging outputs	
16 OUT2 STRT	Starting point for control output 2 when staging outputs	

ALARMS

Parameter	Description	Value
1 ALM. TYPE:1	Type of alarm for alarm 1	
2 ALM. SRC.:1	Source of value being monitored by HIGH or LOW alarm 1	
3 ALARM SP:1	Alarm setpoint alarm 1	
4 DEADBAND:1	Dead band for alarm 1	
5 ALM.:1 OUT.	Output number for alarm 1	
6 LATCHING:1	Latching sequence for alarm 1	
7 ACK.:1	Whether alarm 1 may be acknowledged	
8 POWER UP:1	How alarm 1 will be treated upon power up	
9 MESSAGE:1	Nine character message associated with alarm 1	
10 ALM. TYPE:2	Type of alarm for alarm 2	
11 ALM. SRC.:2	Source of value being monitored by HIGH or LOW alarm 2	
12 ALARM SP:2	Alarm setpoint for alarm 2	
13 DEADBAND :2	Dead band for alarm 2	
14 ALM.:2 OUT.	Output number for alarm 2	
15 LATCHING :2	Latching sequence for alarm 2	
16 ACK.:2	Whether alarm 2 may be acknowledged	
17 POWER UP:2	How alarm 2 will be treated upon power up	
18 MESSAGE:2	Nine character message associated with alarm 2	
19 FAULT	Alarm status if a fault condition is detected	
20 OUTPUT	Output if the rate-of-change alarm is tripped	
21 RATE TIME	Time period over which a rate-of-change will be determined	

Controller Set Up

REM. SETPT.

Parameter	Description	Values
1 TYPE V/mA	Input signal to be used for remote setpoint	
2 RSP: LO RNG.	Eng. unit value for low remote setpoint input value	
3 RSP: HI RNG.	Eng. unit value for high remote setpoint input value	
4 RSP: LOW	Lowest accepted setpoint value from remote setpoint source	
5 RSP: HIGH	Highest accepted setpoint value from remote setpoint source	
6 TRACKING	Whether the local setpoint will track the remote setpoint	
7 BIAS LOW	Lowest bias value that may be entered	
8 BIAS HIGH	Highest bias value that may be entered	
9 RSP FIXED	Status upon restoration of lost remote setpoint	

RETRANS.

Parameter	Description	Values
1 TYPE:2	What is to be retransmitted for retransmission output 2	
2 LOW RANGE:2	Low end of range in eng. units for retransmission output 2	
3 HI RANGE:2	High end of range in eng. units for retransmission output 2	
4 TYPE:3	What is to be retransmitted for retransmission output 3	
5 LOW RANGE:3	Low end of range in eng. units for retransmission output 3	
6 HI RANGE:3	High end of range in engl units for retransmission output 3	
7 TYPE:4	What is to be retransmitted for retransmission output 4	
8 LOW RANGE:4	Low end of range in eng. units for retransmission output 4	
9 HI RANGE:4	High end of range in eng. units for retransmission output 4	

SELF TUNE

Parameter	Description	Value
1 TYPE	Type of self tuning algorithm that is available	
2 PRETUNE	Output step size in absolute percent	
3 TUNE PT.	TYPE 1: Defines the PV value at which the output switches off	
4 OUT. STEP	TYPE 2 & 3: Defines output step size in absolute percent	
5 LOW LIMIT	Lower limit PV can reach during Pretune before aborting	
6 HI LIMIT	Upper limit PV can reach during Pretune before aborting	
7 TIMEOUT	Execution time limit for Pretune before aborting	
8 MODE	Control mode after Pretune is completed or aborted	
9 NOISE BND.	Noise band to be used by adaptive tuning algorithm	
10 RESP. TIME	Response time to be used by adaptive tune	
11 DEAD TIME	Time required to wait before responding to output change	

SPECIAL

Parameter	Description	Value
1 AUTO. TRIP	How controller automatically trips to auto control for manual	
2 TRIP DEV.	Deviation from setpoint at which controller will trip to auto	
3 DES. OUTPT.	Output value on a trip to manual	
4 POWER UP	Control mode upon power up	
5 PWR. UP:OUT.	Output of the controller is powering up in manual control	
6 PWR. UP: SP	Setpoint upon power up	
7 NO. OF SP	#of setpoints stored for selection by digital input or SET PT key	

Controller Set Up

SECURITY

Parameter	Description	Values
1 SEC. CODE	Security code for temporarily unlocking the instrument	
2 SP ADJUST	Lockout status for setpoint changes	
3 AUTO./MAN.	Lockout status of the MANUAL key	
4 SP SELECT	Lockout status of the SET PT key	
5 ALARM ACK.	Lockout status of the ACK key	
6 TUNING	Lockout status for adjustment of tuning parameters	
7 CONFIGURE	Lockout status for Set Up parameters	

SER COMM.

Parameter	Description	Values
1 STATION	The unit's station address	
2 BAUD RATE	Baud rate	
3 CRC	Whether CRC is being calculated	
4 SHED TIME	Time between communications before controller sheds	
5 SHED MODE	State of the controller if communications is lost (sheds)	
6 SHED OUT.	Output if the unit sheds	
7 SHED SP	Setpoint status if communications is lost	
8 DESIG. SP	Value of the setpoint if controller sheds	

CHAPTER 6 TUNING

OVERVIEW

The self tuning function of the 535 consists of two distinct components — Pretune and Adaptive Tune. In addition, you may choose from three types of Pretune:

- TYPE 1 - for slow thermal processes.
- TYPE 2 - for fast fluid or pressure processes.
- TYPE 3 - for level control applications.

You choose the type of Pretune in the SELF TUNE menu.

The Pretune and Adaptive Tune components may be used separately or together.

On the following pages is the step by step guide to the TUNING menu parameters.

NOTE:

For more information about Pretune and Adaptive Tune, refer to the section on Tuning applications in Chapter 7.

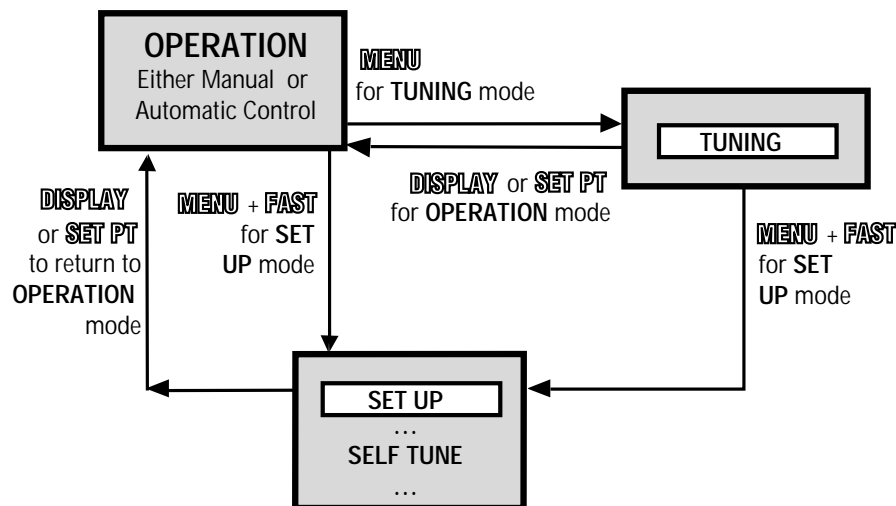
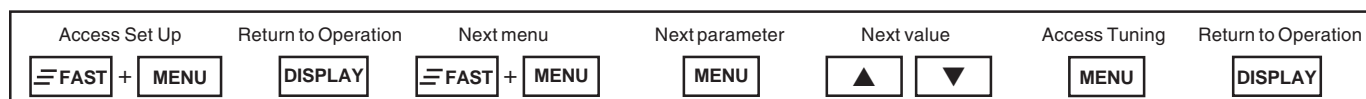

Figure 6.1
Access the Tuning Menu Block



Tuning

TUNING

ADAPTIVE

DISABLED

PRETUNE

NO

POWR. BACK

DISABLED

PROP. BND.:1

50.0

RESET:1

20

RATE:1

1

MAN. RST.:1

0

CYCLE TM.:1

15.0

TUNING

1. ADAPTIVE

Activates the self tune algorithm (upon transfer to automatic control).

D DISABLED

- ENABLED

2. PRETUNE

Activates the pretune algorithm (if unit is under manual control).

To initiate the Pretune cycle, press the ▲ or ▼. Confirm by pressing **ACK** within two seconds.

D NO

3. POWR. BACK

Reduces setpoint overshoot at power up or after setpoint changes.

D DISABLED

- ENABLED

4. PROP. BND.:1

Defines the proportional band for PID set 1.

R 0.1 to 999.0%

D 50.0%

5. RESET:1

Defines the integral time for PID set 1.

R 1 to 9999 seconds

D 20 seconds

6. RATE:1

Defines the derivative time for PID set 1.

R 0 to 600 seconds

D 1 second

7. MAN. RST.:1 (or LOADLINE:1)

Defines the manual reset for PID set 1. If using automatic reset, then this specifies the load line out value.

R 0 to 100%

D 0%

8. CYCLE TM.:1

Defines the cycle time for control output 1 when using a time proportioning output.

R 0.3 to 120.0 seconds

D 15.0 seconds

Access Set Up

Return to Operation

Next menu

Next parameter

Next value

Access Tuning

Return to Operation

≡ FAST + MENU

DISPLAY

≡ FAST + MENU

MENU

▲ ▼

MENU

DISPLAY

9. DEADBAND:1

Defines the dead band for control output 1 when using on/off control.

R 1 to 99999 in engineering units

D 2

DEADBAND:1

2

10. P. PROP. D.B.

Defines the dead band setting for a slidewire position proportioning output.

R 0.5 to 10.0%

D 2.0%

P.PROP.D.B.

2.0

11. A. PID OFST.:1

For duplex applications, defines the offset for the first output.

R -50.0% to 50.0%

D 0.0%

PID OFST.:1

0

11B. ON OFST.:1

For On/Off applications, defines the offset for the first output.

R -9999 to 99999 in engineering units

D 0

ON/OFT.:1

0

12A. PID OFST.:2

For duplex applications, defines the offset for the second output.

R -50.0% to 50.0%

D 0.0%

PID OFST.:2

0

12B. ON OFST.:2

For On/Off applications, defines the offset for the second output.

R -9999 to 99999 in engineering units

D 0

ON/OFT.:2

0

13. REL. GAIN:2

Defines the adjustment factor for the second output's proportional band. It is multiplied by the effective gain of output 1 to obtain the second output's proportional band.

R 0.1 to 10.0

D 1.0

REL. GAIN:2

1.0

14. CYCLE TM.:2

Defines the cycle time for control output 2 when using a time proportioning output.

R 0.3 to 120.0 seconds.

D 15.0 seconds

CYCLE TM.:2

15.0

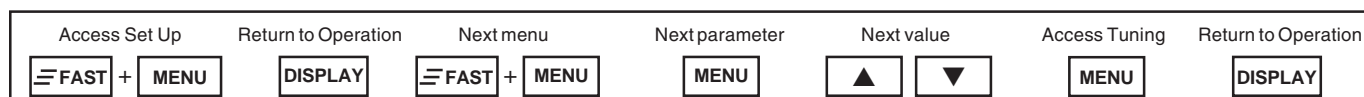

Tuning

DEADBAND:2

2

RSP RATIO

1.00

RSP BIAS

(D)

NO. OF PID

1

PID TRIP

SP VALUE

TRIP:1

(D)

15. DEADBAND:2

Defines the dead band for control output 2 when using on/off control.

R 1 to 99999 in engineering units

D 2

16. RSP RATIO

Defines the multiplier applied to the remote set point.

R -99.99 to 99.99

D 1.00

17. RSP BIAS

Defines the bias (additive term) applied to the remote set point.

R Any value in engineering units (minimum is BIAS LOW; maximum is BIAS HIGH)

D Dependent on the BIAS LOW and BIAS HIGH values

18. NO. OF PID

Defines the number of PID sets that will be stored and available for use.

R 1 to 8

For numbers > 1, PID TRIP defines tripping between the PID sets

- SP NUMBER Number of PID sets = number of local setpoints (specified in NO. OF SP). Each PID set has a respective SP NUMBER.
- PV NUMBER PID Set = the process variable (PV1 or PV2) used when PV SOURCE = 1/2: SWITCH or PV SOURCE = 1/2:BACKUP

D 1

19. PID TRIP

For NO. OF PID > 1, defines the variable used to select the various PID sets.

- PV VALUE PID set selection based on process variable
- D SP VALUE PID set selection based on setpoint
- DEV. VALUE PID set selection based on deviation from setpoint

20. TRIP:1

Defines the value that triggers a change to the primary set (#1) of PID values.

R The process variable range

D Dependent on the process variable range

FOR EACH SET OF PID 2 THROUGH 8, you need to set up the following group of parameters (X represents the PID set number). Set up the parameters as they appear for each set of PID. **The controller designates the values for the active PID parameter in the third display with an "*" on either side.**

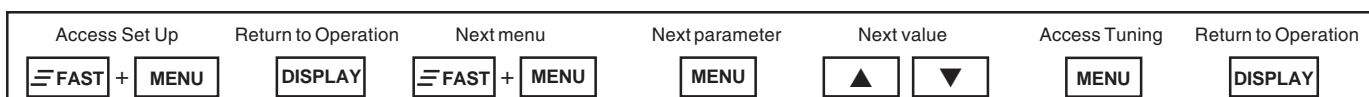

21. PROP. BND.:X

Defines the proportional band for PID set X.

R 0.1 to 999.0%

D 50.0%

PROP.BND.:X

(D)

22. RESET:X

Defines the integral time for PID set X.

R 1 to 9999 seconds (increments of 1)

D 20 seconds

RESET:X

(D)

23. RATE:X

Defines the derivative time for PID set X.

R 0 to 600 seconds

D 1 seconds

RATE:X

1

24. MAN. RST.:X (or LOADLINE:X)

Defines the manual reset (or load line) for PID set X.

R 0 to 100%

D 0%

MAN.RST.:X

0

25. TRIP:X

This defines the value that triggers a change to the Xth set of PID values.

R The process variable range

D Dependent on the process variable range

TRIP:X

(D)

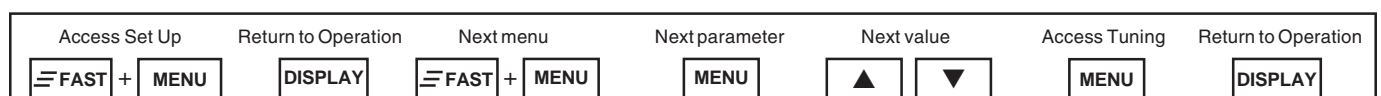

TUNING

Parameter	Definition	Values
1. ADAPTIVE	Activates the self tune algorithm.	
2. PRETUNE	Activates the pretune algorithm.	
3. POWR. BACK	Reduces setpoint overshoot.	
4. PROP. BND.:1	Defines the proportional band for PID set 1.	
5. RESET:1	Defines the integral time for PID set 1.	
6. RATE:1	Defines the derivative time for PID set 1.	
7. MAN. RST.:1	Defines the manual reset for PID set 1.	
8. CYCLE TM.:1	Defines the cycle time for control output 1.	
9. DEADBAND:1	Defines the dead band for control output 1.	
10. P. PROP. D.B.	Defines the dead band setting for a slidewire output.	
11A. PID OFST.:1	For duplex applications, defines the offset for the first output.	
11B. ON OFST.:1	For On/Off applications, defines the offset for the first output.	
12A. PID OFST.:2	For duplex applications, defines the offset for the 2nd output.	
12B. ON OFST.:2	For On/Off applications, defines the offset for the 2nd output.	
13. REL. GAIN:2	Defines the adjustment factor for the output 2 prop. band.	
14. CYCLE TM.:2	Defines the cycle time for control output 2.	
15. DEADBAND:2	Defines the dead band for control output 2.	
16. RSP RATIO	Defines the multiplier applied to the remote set point.	
17. RSP BIAS	Defines the bias (additive term) applied to the remote set point.	
18. NO. OF PID	Defines the number of stored and available PID sets.	
19. PID TRIP	Defines the variable used to select the various PID sets.	
20. TRIP:1	Defines the value that triggers a change to primary PID set.	
21. PROP. BND.:2	Defines the proportional band for PID set 2.	
22. RESET:2	Defines the integral time for PID set 2.	
23. RATE:2	Defines the derivative time for PID set 2.	
24. MAN. RST.:2	Defines the manual reset (or load line) for PID set 2.	
25. TRIP:2	Defines the value that triggers a change to the 2nd PID set.	
26. PROP. BND.:3	Defines the proportional band for PID set 3.	
27. RESET:3	Defines the integral time for PID set 3.	
28. RATE:3	Defines the derivative time for PID set 3.	
29. MAN. RST.:3	Defines the manual reset (or load line) for PID set 3.	

30. TRIP:3	Defines the value that triggers a change to the 3rd PID set.	
31. PROP. BND.:4	Defines the proportional band for PID set 4.	
32. RESET:4	Defines the integral time for PID set 4.	
33. RATE:4	Defines the derivative time for PID set 4.	
34. MAN. RST.:4	Defines the manual reset (or load line) for PID set 4.	
35. TRIP:4	This defines the value that triggers a change to the 4th PID set.	
36. PROP. BND.:5	Defines the proportional band for PID set 5.	
37. RESET:5	Defines the integral time for PID set 5.	
38. RATE:5	Defines the derivative time for PID set 5.	
39. MAN. RST.:5	Defines the manual reset (or load line) for PID set 5.	
40. TRIP:5	This defines the value that triggers a change to the 5th PID set.	
41. PROP. BND.:6	Defines the proportional band for PID set 6.	
42. RESET:6	Defines the integral time for PID set 6.	
43. RATE:6	Defines the derivative time for PID set 6.	
44. MAN. RST.6	Defines the manual reset (or load line) for PID set 6.	
45. TRIP:6	This defines the value that triggers a change to the 6th PID set.	
46. PROP. BND.:7	Defines the proportional band for PID set 7.	
47. RESET:7	Defines the integral time for PID set 7.	
48. RATE:7	Defines the derivative time for PID set 7.	
49. MAN. RST.:7	Defines the manual reset (or load line) for PID set 7.	
50. TRIP:7	This defines the value that triggers a change to the 7th PID set.	
51. PROP. BND.:8	Defines the proportional band for PID set 8.	
52. RESET:8	Defines the integral time for PID set 8.	
53. RATE:8	Defines the derivative time for PID set 8.	
54. MAN. RST.:8	Defines the manual reset (or load line) for PID set 8.	
55. TRIP:8	This defines the value that triggers a change to the 8th PID set.	

SELF TUNE MESSAGES AND TROUBLESHOOTING

Refer to Chapter 7 for more information on the Self Tune function of the 535 controller.

When the Pretune function terminates, one of the following messages will appear:

Message	Pretune Type	Conclusion/Problem	Corrective Action
COMPLETED	1	PRETUNE has generated initial PID and the Dead Time values.	
	2, 3	PRETUNE has generated initial PID, Response Time, Noise Band and the Dead Time values.	
ABORTED	1, 2, 3	User has aborted PRETUNE before completion.	
LIMIT ERR.	1	The Process Variable went beyond the HI LIMIT or LOW LIMIT.	Change the HI LIMIT and LOW LIMIT, or the HIGH OUT and LOW OUT, and run PRETUNE again.
	2, 3	The Process Variable went beyond the HI LIMIT or LOW LIMIT.	Change the HI LIMIT and LOW LIMIT, or the OUT.STEP size, and run PRETUNE again.
	1, 2, 3	The initial Process Variable was near or beyond the HI LIMIT or LOW LIMIT.	Change the manual output percentage, or the HI LIMIT and LOW LIMIT, and run PRETUNE again.
TIME OUT	1, 2, 3	TIMEOUT limit was reached before PRETUNE completed.	Set a longer TIMEOUT period and/or increase the OUT.STEP size, and run PRETUNE again.
NOISE ERR.	1, 2, 3	Too much PV noise was detected.	Eliminate the noise source (if possible) or increase the OUT.STEP and run PRETUNE again.
INPUT ERR.	1, 2, 3	PV or Cold Junction break detected during PRETUNE.	Check the described conditions and make corrections or repairs.
	1, 2, 3	PV HIGH or PV LOW detected during PRETUNE.	
	1, 2, 3	SLIDEWIRE break detected during PRETUNE.	
	1, 2, 3	REMOTE SP break detected during PRETUNE.	
OUT. ERROR	1, 2, 3	The initial control output is outside the high and low limits defined in the Control Menu.	Change the manual output percent and run PRETUNE again.
DATA ERR.	2,3	The PV moved too quickly to be Analyzed.	Increase the OUT.STEP size and run PRETUNE again.
ZERO ERR.	2,3	One or more model parameters are calculated to be zero.	Increase the OUT.STEP size and run PRETUNE again.
DEV. ERROR	1	The initial PV is too close to the TUNE PT.	Move Tune PT. (or the set point if TUNE PT. is automatic) farther from the process variable and run PRETUNE again.
RETRY	1, 2, 3	The Process Variable went beyond the HI LIMIT or LOW LIMIT	Check if any PID values are generated and if they are acceptable. If not, eliminate noise sources (if possible) and run PRETUNE again.

If Pretune and Adaptive Tune do not generate optimal PID values for control, check the following menu entries:

Message	Potential Problem	Corrective Action
RESPONSE TIME	Adaptive Tune cannot run if RESPONSE TIME is inaccurate	Run TYPE 2 or TYPE 3 Pretune to obtain the correct value, or enter it manually.
NOISE BAND	Adaptive Tune cannot compensate for PV oscillation due to hysteresis of output device (e.g., a sticky valve).	Set NOISE BAND large enough to prevent Adaptive Tune from acting on the oscillation. If oscillation is not acceptable, consider replacing valve.
PRETUNE	Pretune does not develop optimum PID parameters.	Wrong Pretune TYPE selected. Refer to Chapter 7, the Section on Self Tune.

CHAPTER 7 APPLICATIONS

NOTE: Controller capabilities depend upon the specified hardware option.

The 535 controller provides a variety of user-programmable control features and capabilities. The following topics are included in this chapter:

A. Control Type	71	I. Remote Setpoint	86	Q. Security	97
B. Alarms	72	J. Multiple Setpoints	87	R. Reset Inhibition	98
C. Duplex Control	76	K. Multiple Sets of PID Values	87	S. Process Variable Reading Correction	98
D. Slidewire Position Proportioning Control ..	81	L. Powerback	88	T. Serial Communications	99
E. Velocity Position Proportioning Control	82	M. Self Tune—POWERTUNE®	89	U. Cascade Control	100
F. Staged Outputs	83	N. Ramp-to-Setpoint	94	V. Ratio Control	103
G. Retransmission	83	O. Input Linearization	95		
H. Digital Inputs	84	P. Load Line	97		

A. CONTROL TYPE

Software Configuration

1. Go to the **CONTROL** menu.
2. For the parameter **ALGORITHM**, select the type of 535 control:
 - **ON-OFF**
“Crude” control similar to a household thermostat. Used primarily on slow, stable processes where moderate deviation (cycling) around setpoint is tolerable. Only available with SSR, SSR Drive, and relay outputs.
 - **P**
Proportional only control. Provides much better control than on/off. Used on processes that are less stable or require tighter control, but have few load variations and do not require a wide range of setpoints.
 - **PI**
Proportional plus integral control. In addition to proportional control, it compensates for control errors due to wide range of setpoints or load requirements. The integral term works to eliminate offsets.
 - **PD**
Proportional plus derivative control. In addition to proportional control, it compensates for control errors due to fast load variations.
 - **PID**
Proportional plus integral plus derivative control. In addition to proportional control, it compensates for changes in setpoint, load requirements and process variations.
 - **PID/ON-OFF**
Only available with Duplex control. First output uses the PID algorithm, while second output uses on/off control.
3. For algorithms using the derivative function (D), choose the conditions for the derivative term:

Scroll to parameter **D. SOURCE**

- For derivative action based on error, or deviation from setpoint, choose **DEVIATION**
- For derivative action based on process variable changes, choose **PV**.

B. ALARMS

The 535 controller has two extremely flexible and powerful software alarms. The number of available outputs limits how alarms are linked to relays. A Global Alarm feature allows all alarms to be assigned to the same relay.

The 535 indicates an alarm condition by:

- Lighting up the alarm icon(s)
- Displaying a custom message in the 3rd display
- Illuminating the **ACK** key (if the alarm is acknowledgeable)

Software Configuration

1. Access the **ALARM** menu.
2. Set values for the following parameters. All possible values are shown.

ALM.TYPE:1 and ALM.TYPE:2

Specifies the type of alarm to implement. Selection includes:

- **HIGH ALARM**
High process variable alarm. Occurs when the process variable exceeds the alarm setpoint.
- **LOW ALARM**
Low process variable alarm. Occurs when the process variable goes below the alarm setpoint.
- **HIGH/LOW**
Combination of high and low alarms. Occurs when the PV exceeds the individually set high or low setpoint.
- **BAND**
Creates a band centered around the control setpoint, that is twice the alarm setpoint. Alarm occurs when the process variable travels outside of this band. The alarm is dependent on the control setpoint. As the control setpoint changes, the band adjusts accordingly.
For example, if the control setpoint is 500 and the alarm setpoint is 25, then the band extends from 475 to 525.
- **DEVIATION**
Similar to the band alarm but creates a band only on one side of the control setpoint. Alarm occurs when the process variable deviates from the control setpoint by an amount greater than the alarm setpoint. This alarm is dependent on the control setpoint; as the control setpoint changes, the alarm point changes.
For example, if the control setpoint is 500 and the alarm setpoint is +50, then an alarm occurs when the process variable exceeds 550. In order for an alarm to occur when the process variable drops below 450, select an alarm setpoint of -50.

NOTE: Specifying a variable other than the setpoint (SP) to **HIGH ALARM** and **LOW ALARM** allows for greater flexibility in creating alarm and control strategies.

- **MANUAL**

Alarm occurs when the controller is put into manual mode of operation. This may be useful for security purposes or to alert the operator that 535 is no longer under automatic control.

- **RATE**

Alarm occurs when the process variable changes at a rate greater than what is specified by the alarm setpoint and time base. This alarm helps to anticipate problems before the process variable can reach an undesirable level.

For example, if the alarm setpoint is 10 with a time base of 5 seconds, an alarm occurs whenever a change in process variable greater than 10 occurs in 5 seconds.

ALM.SRC.:1 and ALM.SRC.:2

For HIGH, LOW or HIGH/LOW alarms, specifies the variable (source) upon which a selected alarm is based. Selection includes:

- PV
- PV2
- SP
- RAMP SP
- DEVIATION
- OUTPUT

ALARM SP:1 and ALARM SP:2

Defines the point at which an alarm occurs. For a RATE (rate of change) alarm, it specifies the amount of change (per RATE TIME period) that must occur before the alarm activates. A negative value specifies a negative rate-of-change. Does not apply to HIGH/LOW alarms.

HIGH SP:1 and HIGH SP:2

For a HIGH/LOW alarm, defines the high setpoint at which an alarm occurs.

LOW SP:1 and LOW SP:2

For a HIGH/LOW alarm, defines the low setpoint at which an alarm occurs.

DEADBAND:1 and DEADBAND:2

Specifies the range through which the process variable must travel before leaving an alarm condition (see alarm examples at the end of this section). Prevents frequent alarm oscillation or “chattering” if the process variable has stabilized around the alarm point.

ALM.1 OUT and ALM.2 OUT

For any enabled alarm, selects the output number to which the selected alarm will be assigned. It is possible to assign both alarms to the same output relay, thus creating a “global” alarm application.

LATCHING:1 and LATCHING:2

A latching (YES) alarm will remain active after leaving the alarm condition unless it is acknowledged. A non-latching (NO) alarm will return to the non-alarm state when leaving the alarm condition without being acknowledged.

Alarm Parameters Reference

For Alarm 1

Parameter	Description
ALM. TYPE:1	Type
ALM. SRC.:1	Source
ALARM SP:1	Setpoint
HIGH SP:1	High setpoint
LOW SP:1	Low setpoint
DEADBAND:1	Deadband
ALM.:1 OUT.	Output number
LATCHING:1	Latching sequence
ACK.:1	Acknowledging
POWER UP:1	Status on power up
MESSAGE:1	Message

For Alarm 2

Parameter	Description
ALM. TYPE:2	Type
ALM. SRC.:2	Source
ALARM SP:2	Setpoint
HIGH SP:2	High setpoint
LOW SP:2	Low setpoint
DEADBAND:2	Deadband
ALM.:2 OUT.	Output number
LATCHING:2	Latching sequence
ACK.:2	Acknowledging
POWER UP:2	Status on power up
MESSAGE:2	Message

For either alarm

(depending on choices)

Parameter	Description
FAULT	Fault assignment
OUTPUT	Output action for rate
RATE TIME	Time base for rate

ACK.:1 and ACK.:2

For any enabled alarm, enables or disables operator use of the **ACK** key to acknowledge an alarm at any time, even if the control process is still in the alarm condition.

A latching alarm can always be acknowledged when it is out of the alarm condition. When either alarm is available to be acknowledged, the **ACK** key will be illuminated. If both alarms are acknowledgeable, pressing **ACK** will first acknowledge alarm #1. Pressing **ACK** a second time will acknowledge alarm #2.

POWER UP:1 and POWER UP:2

For any enabled alarm, selects the alarm condition upon power up. Choices are:

- **NORMAL**
Controller will power up in alarm only if it is in alarm condition.
- **ALARM:**
Controller always powers up in alarm regardless of system's alarm condition. This is an excellent way to activate an alarm if there has been a power failure.
- **DELAYED**
Controller will never power up in alarm, regardless of system's alarm condition. The system must leave and reenter the alarm condition before the alarm will activate. This is typically used to avoid alarms during start up.

MESSAGE:1 and MESSAGE:2

Allows user to specify a nine-character message to be displayed when the respective alarm is active. If both alarms are active or any other diagnostic message is present, the messages will alternate.

FAULT

Activates an alarm if the process variable signal is lost. Assign this function to either Alarm 1 or Alarm 2 (not both). This action is in addition to the selected alarm type (additive alarm function).

OUTPUT

For a RATE alarm, selects the output action. Use to obtain early indication of a possible break in the process variable signal. Select PV BREAK to have rate-of-change alarm take the same action as a detection of a break in the process variable signal (where it trips to manual control at a predetermined output).

RATE TIME

For RATE alarms, defines the time period over which a discrete change in process variable must occur for the rate alarm to be activated. The amount of change is defined by the alarm setpoint. The rate-of-change is defined as the amount of change divided by the time period.

Example

- If the alarm setpoint is set to 10 and the time base is set to 1 second, the rate of change is 10 units per second.
- If the alarm setpoint is set to 100 and the time base set to 10, the rate of change is also 10 units per second.

In example A, the process variable would only have to experience a ten unit change over a short period of time, while in Example B, it would require a 100 unit change over a ten second period. Example A is much more sensitive than Example B. In general, for a given rate-of-change, the shorter the time period, the more sensitive the rate alarm.

Figure 7.1
Alarm Examples

BAND ALARM

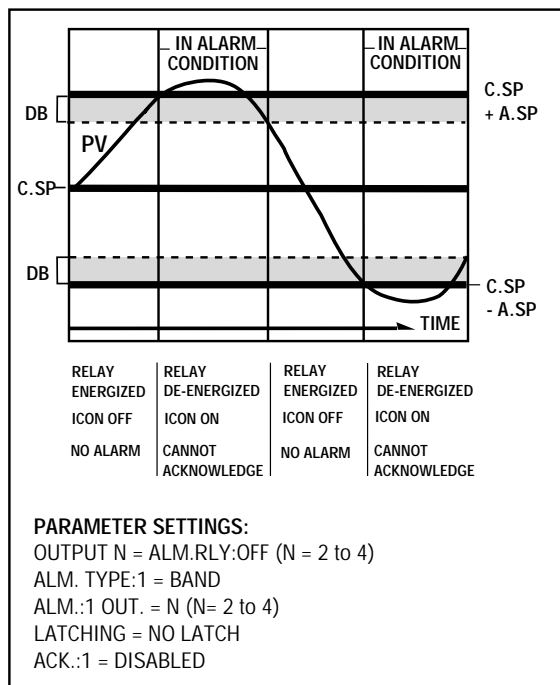

HIGH PROCESS VARIABLE ALARM

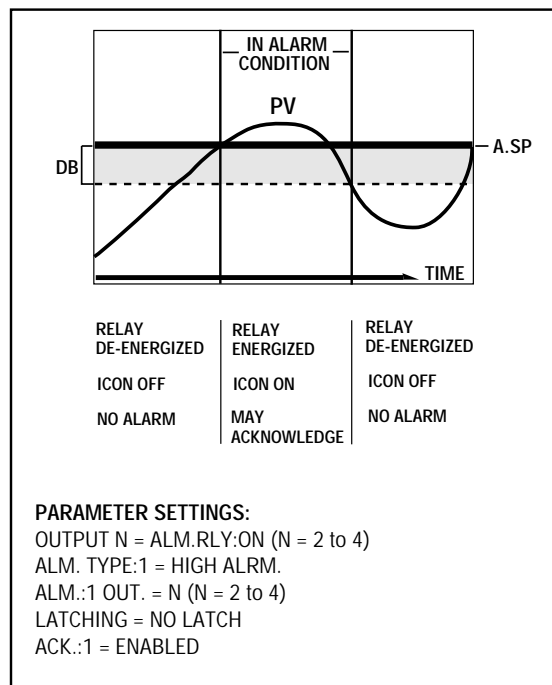

DEVIATION ALARM

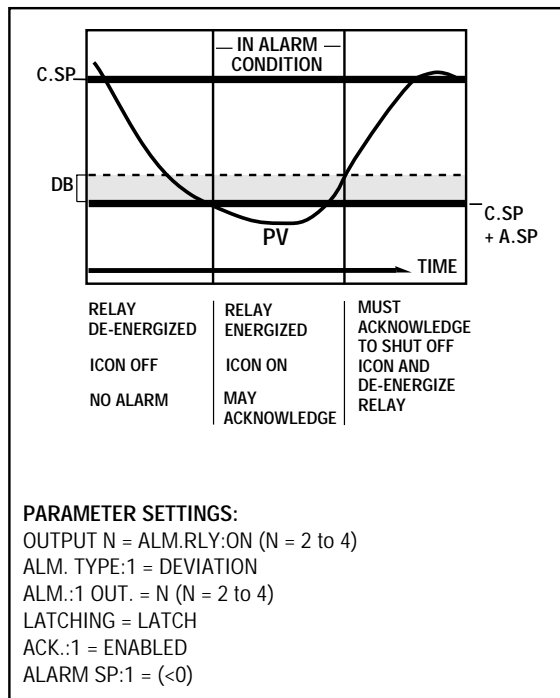

POWER UP ALARM

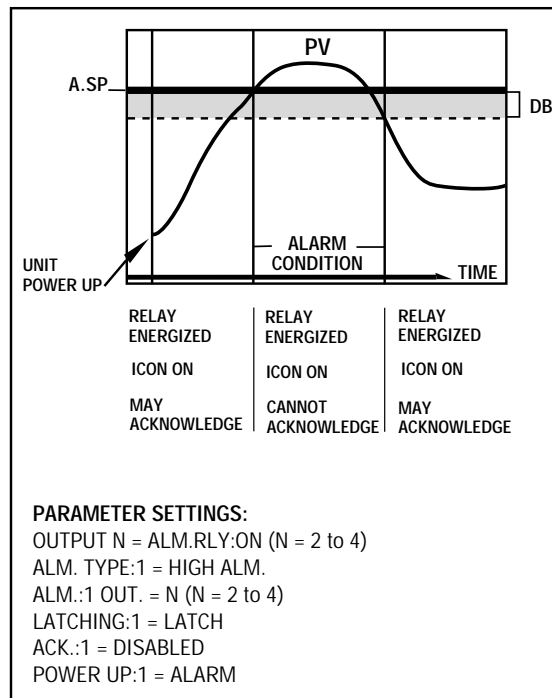

NOTE: The duplex output states vary depending upon:

1. Control Type (PID, On/Off, etc.)
2. Control Action (DA, RA)
3. Output Limits
4. Output Gap or Overlay, and
5. Output 2 Relative Gain and PID% Output.

Please refer to the output state examples in this section to confirm that the configuration is appropriate for the process.

NOTE: Set manual reset/load line parameters to 50% when using Duplex control (**MAN. RST.:X** parameter is in the **TUNING** menu.)

C. DUPLEX CONTROL

The Duplex control algorithm enables two discrete control outputs for the control loop. Duplex control is commonly used for applications that require both heating and cooling or when 2 control elements are needed to achieve the desired result.

Hardware Configuration

- The controller must have two output modules assigned to the loop (any combination of output modules).

Software Configuration

1. Go to the **CONFIG.** menu.
Set **CTRL.TYPE** to **DUPLEX.**
2. To use different algorithms for each output (PID for the first, and On/Off for the second):
Go to the **CONTROL** menu.
Set **ALGORITHM** to **PID:ON/OFF.**
3. To make the control action for each output independent of the other:
Go to the **CONTROL** menu.
Set **ACTION:1** or **ACTION:2** to either **DIRECT** or **REVERSE** action based on the diagrams in the output examples section (Figures 7.2 through 7.8).
4. Go to the **TUNING** menu.
Set values for **PID OFST:1** (or **ON OFST:1**) and **PID OFST:2** (or **ON OFST:2**). These parameters allow the user to independently offset the point at which output 1 and output 2 become active. **PID OFFSET** units are in percent (%) of control output; **ON OFST** is in engineering units. The settings can be used to make sure there is a dead band, i.e., no controller output around setpoint. They can also be used to overlap output 1 and output 2 so that both are “on” in a small band around setpoint.
5. Set **MAN. RESET** (manual reset) term to 50%. This causes the PID output to be 50% when there is zero error. This term is still active as a “load line” setting when using automatic reset (integral), so set it to 50% whether using automatic reset or not.
6. **REL. GAIN** (relative gain) changes the gain of Output 2 relative to Output 1. Note that the relative gain can limit the maximum output available for Output 2 when using PID control.
7. Go to the **CONTROL** menu.
Set **LOW OUT.** and **HIGH OUT.** to limit the maximum or minimum outputs from Output 1 and Output 2. The actual limitation on the outputs is dependent on the offset settings, the relative gain setting and the control action.

Duplex Output State Examples

The following Duplex examples represent a variety of ways this function can be set up. PID control examples show the PID output percentage on the horizontal axis, and On/Off control examples show the process variable on the horizontal axis. The vertical axes are the output of each physical output. Most of these examples use the first output as heating and the second output as cooling.

When using PID control, the 535 controller actually displays the PID output. To relate this output to the actual physical output, locate the PID output on the

horizontal axis. Draw a vertical line at that point. At the intersection of this vertical line and the respective output line, draw a horizontal line. The physical output is the value where this horizontal line intersects the respective axis.

The illustrations assumes a manual reset/load line term of 50%. Therefore, at zero error (process variable equals setpoint) the PID output is 50%.

Duplex with reverse and direct acting outputs

A reverse acting output 1 and a direct acting output 2 with: no offset, no restrictive outputs limits, and a neutral relative gain with PID control.

PARAMETER SETTINGS
 ACTION:1 = REVERSE
 ACTION:2 = DIRECT
 PID OFST.:1 = 0
 PID OFST.:2 = 0
 LOW OUT = 0
 HIGH OUT = 100
 REL. GAIN = 1.0

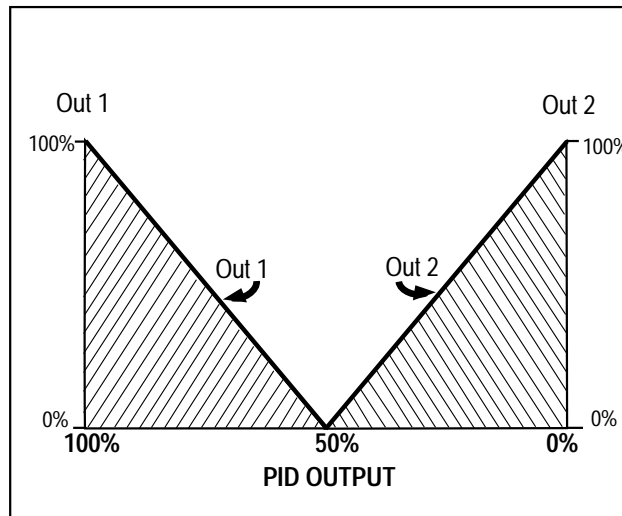

Figure 7.2
 Duplex with Reverse and Direct Acting Outputs

Duplex with direct and reverse acting outputs

A reverse acting output 1 and a direct acting output 2 with: no offset, no restrictive output limits, and a neutral relative gain with PID control.

PARAMETER SETTINGS
 ACTION:1 = DIRECT
 ACTION:2 = REVERSE
 PID OFST.:1 = 0
 PID OFST.:2 = 0
 LOW OUT = 0
 HIGH OUT = 100
 REL. GAIN = 1.0

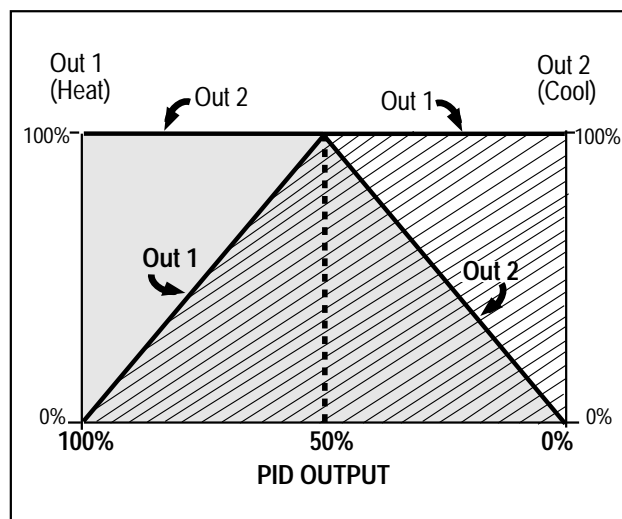

Figure 7.3
 Duplex with Direct and Reverse Acting Outputs

Duplex with 2 reverse acting outputs

Two reverse acting outputs with: no offset, no restrictive output limits, and a neutral relative gain with PID control.

PARAMETER SETTINGS
 ACTION:1 = REVERSE
 ACTION:2 = REVERSE
 PID OFST.:1 = 0
 PID OFST.:2 = 0
 LOW OUT = 0
 HIGH OUT = 100
 REL. GAIN = 1.0

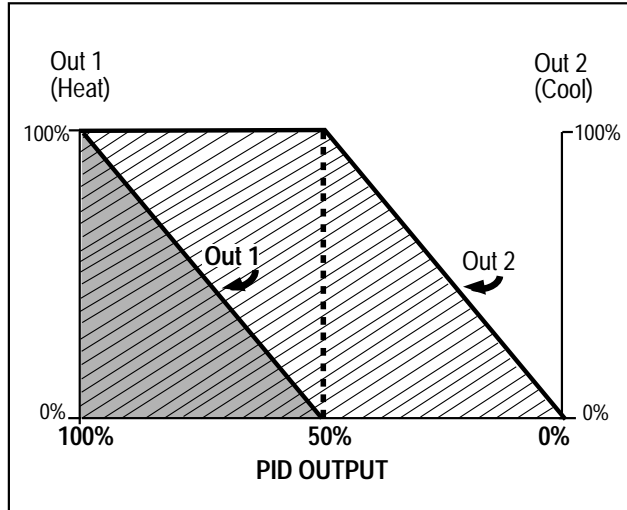

Figure 7.4
 Duplex with Two Reverse Acting Outputs

Duplex with a gap between outputs

A reverse acting output 1 and a direct acting output 2 react with: a positive offset for output 1 and a negative offset for output 2 (assume no restrictive output limits and a neutral relative gain with PID control).

On the graph, a positive offset refers to an offset to the left of 50%; a negative offset is to the right of 50%.

PARAMETER SETTINGS
 ACTION:1 = REVERSE
 ACTION:2 = DIRECT
 PID OFST.:1 = + VALUE
 PID OFST.:2 = - VALUE
 LOW OUT = 0
 HIGH OUT = 100
 REL. GAIN = 1.0

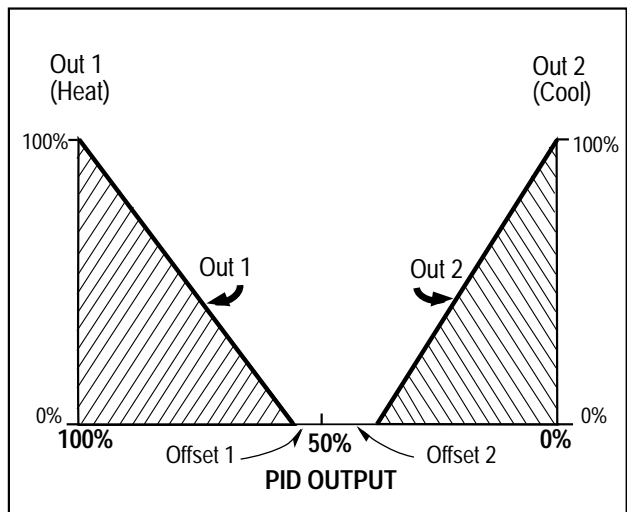

Figure 7.5
 Duplex with a Gap Between Outputs

Duplex with overlapping outputs and output limits

A reverse acting output 1 and a direct acting output 2 with: a negative offset for output 1, a positive offset for output 2, and restrictive high and low output limits with PID control.

This combination of offsets results in an overlap where both outputs are active simultaneously when the PID output is around 50%.

The output limits are applied directly to the PID output. This in turn limits the actual output values. In this example, the high output maximum limits the maximum value for output 1, while the low output minimum limits the maximum value for output 2. The value the actual outputs are limited to depends on offset settings, control action and relative gain setting with PID control.

PARAMETER SETTINGS

ACTION:1 = REVERSE
 ACTION:2 = DIRECT
 PID OFST.:1 = - VALUE
 PID OFST.:2 = + VALUE
 LOW OUT = 10%
 HIGH OUT = 85%
 REL. GAIN = 1.0

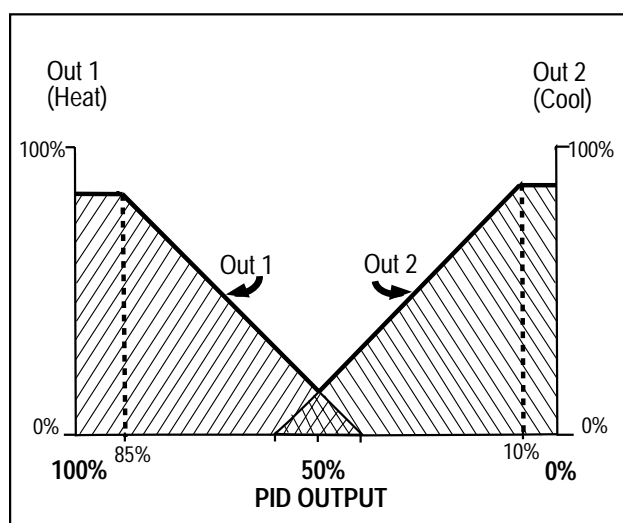

Figure 7.6
 Duplex with Overlapping Outputs
 and Output Limits

Duplex with various relative gain settings

A reverse acting output 1 and a direct acting output 2 with: various relative gain settings (assume no offset or restrictive outputs) with PID control.

PARAMETER SETTINGS

ACTION:1 = REVERSE
 ACTION:2 = DIRECT
 PID OFST.:1 = 0
 PID OFST.:2 = 0
 LOW OUT = 0
 HIGH OUT = 100
 REL. GAIN ① = 2.0
 REL. GAIN ② = 1.0
 REL. GAIN ③ = 0.5

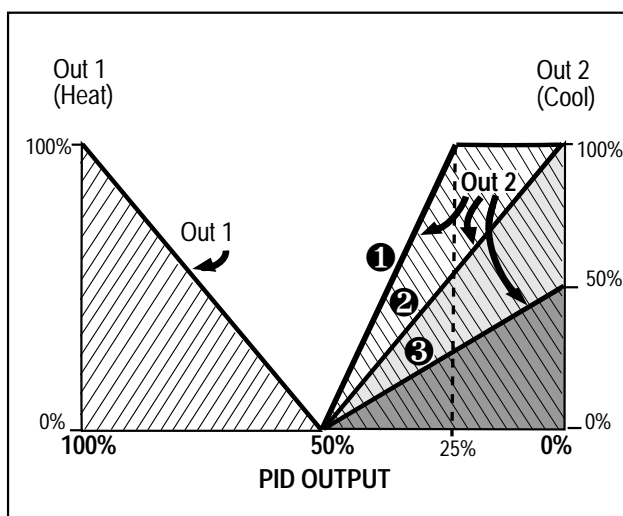

Figure 7.7
 Duplex with Various Relative Gain
 Settings

Notice that the relative gain setting does not affect output 1. In this example, a relative gain setting of 2.0 (curve 1) results in output 2 reaching its maximum value at a PID output of 25%. A relative gain setting of 1.0 results in output 2 reaching its maximum value at a PID output of 0%. A relative gain setting of 0.5 results in output 2 reaching a maximum of 50% at a PID output of 0%.

Duplex with one ON/OFF output

A reverse acting output 1 and a direct acting, on/off output 2 with a positive offset. Relative gain does not apply when using duplex with an on/off output. The deadband setting for output 2 works the same as the deadband in single on/off control (the deadband effect for output 2 is not illustrated here).

PARAMETER SETTINGS
 ACTION:1 = REVERSE
 ACTION:2 = DIRECT
 PID OFST.:1 = 0
 ON OFST.:2 = + VALUE
 LOW OUT = 0
 HIGH OUT = 100

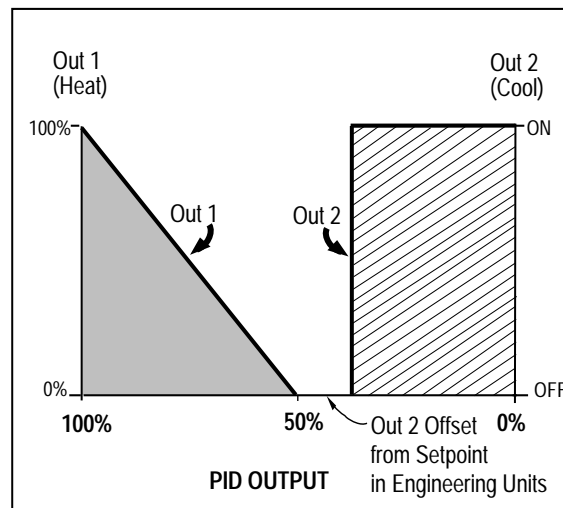

Figure 7.8
 Duplex with One ON/OFF Output

Duplex with two ON/OFF outputs

A reverse acting on/off output 1 and a direct acting on/off output 2 with a negative offset for output 1 and a positive offset for output 2.

Note that here the horizontal axis is expressed in terms of process variable rather than PID output.

PARAMETER SETTINGS
 ACTION:1 = REVERSE
 ACTION:2 = DIRECT
 ON OFST.:1 = - VALUE
 ON OFST.:2 = + VALUE

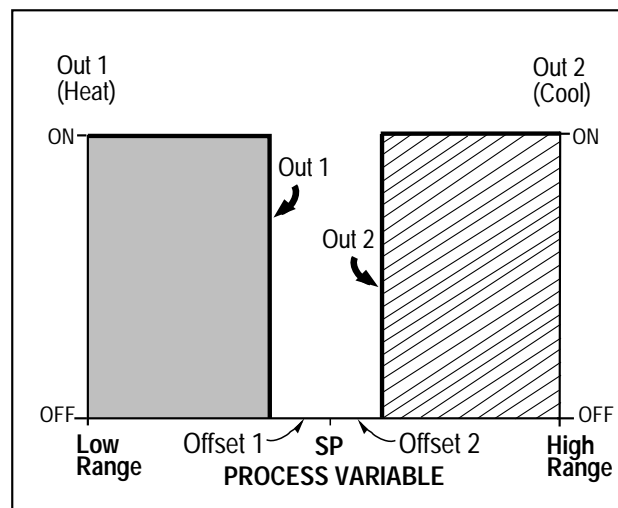

Figure 7.9
 Duplex with Two ON/OFF Outputs

D. SLIDEWIRE POSITION PROPORTIONING CONTROL

Slidewire position proportioning utilizes a slidewire feedback signal to determine the actual position of the actuator being controlled.

Hardware Configuration

- The controller **must** have the Slidewire Feedback option installed. Refer to the order code in Chapter 1 for more information.
- The controller must have mechanical relays, solid state relays or DC logic modules installed in the first two output sockets.
- The Slidewire does NOT have to be wired to the controller in order to set up position proportioning.

Software Configuration

1. To configure the controller before wiring the slidewire feedback signal to the controller, complete these steps:
 - a. Go to the **CONTROL** menu.
 - b. Set a value for **PV BREAK**.
 - c. Go to the **SPECIAL** menu.
 - d. Set a value for **DES. OUTPT**.
 - e. Set a value for **PWR.UP:OUT**.
 - f. Go to **SER. COMM.** menu.
 - g. Set a value for **SHED OUT**.
2. Place the controller under manual control.
3. Go to the **CONFIG** menu.
4. Set **CTRL. TYPE** to POS. PROP (position proportioning).
5. Set **P.P. TYPE** to SLIDEWIRE.
6. Go to the **CONTROL** menu.
7. For **S/W RANGE**, specify the full range resistance of the slidewire from end-to-end. With a 100 ohm slidewire, this parameter should be set to 100.
8. Scroll to **OPEN F/B** (Open feedback). Enter the ohm value when the actuator is fully open (0 to 1050 ohms).
9. Scroll to **CLOSE F/B** (Closed feedback). Enter the ohm value when the actuator is fully closed (0 to 1050 ohms).
10. Measure the actual slidewire value at the terminals (10 and 11).
 As an alternative, set up these two parameters dynamically. Before entering Set Up set the manual output at 100%. Enter Set Up and change the **OPEN F/B** value until the actuator just reaches its full open position.
 Exit Set Up and set the manual output to 0%. Enter configuration and change the **CLOSE F/B** value until the actuator just reaches its full closed position.
11. Set the parameter **P. PROP. D.B.**, which is used to eliminate cycling of the motor. A low deadband setting may result in motor overspin or cycling. A high deadband will result in reduction of sensitivity. To set:
 - a. Go to the **TUNING** menu.
 - b. Set **P. PROP. D.B.** to .5%.
 - c. Place controller under Manual control.
 - d. Change the output percentage and observe if the valve stabilizes at the new value.

CAUTION!

The relay in socket 1 drives the motor counterclockwise and the relay in output socket 2 drives the motor clockwise.

This is important for:

- Wiring the outputs
- Selecting the control **ACTION:1** parameter, or
- Determining the normally open or normally closed relays,

The configuration choices influence the way the position proportioning algorithm works.

NOTE: OPEN F/B and CLOSE F/B values are always reference to the CCW end of the Slidewire.

NOTE: P.PROP.D.B. can only be configured if the Slidewire Feedback is wired to the controller.

- e. If the valve oscillates, increase the **P.PROP.D.B.** value by 0.5%; repeat until oscillation stops.
12. Set the parameter **S/W BREAK** to define the output value for when the slide-wire breaks.

E. VELOCITY POSITION PROPORTIONING CONTROL

Velocity position proportioning does not utilize direct feedback. It estimates the position of the actuator, based on time and the speed of the actuator.

NOTE: Adaptive tuning is not available with velocity position proportioning control.

In automatic control mode, the controller will display “CW” to refer to energizing of the clockwise relay, and “CCW” to refer to energizing of the counterclockwise relay. A blank display means that both relays are de-energized.

In manual control mode, the display is blank unless an output change is being made. Use the ▲ and ▼ keys to change the output; the relay is only energized while the keys are being pressed. The display indicates the percentage change in valve position in real time. The rate of change is dependent on the values entered for **CCW TIME** and **CW TIME**.

The controller will transfer to manual control due to a lost process variable (**PV. BREAK**), a digital input closure (**DES.OUTPT.**), a power-up sequence (**PWR.UP:OUT.**), or lost communications (**SHED OUT**). In these cases, the output can be set to: remain at its last value with both relays de-energized (**OUTS OFF**); rotate fully counterclockwise (**CCW**); or rotate fully clockwise (**CW**). **CCW** and **CW** will energize the respective relay for a period two times that of the **CCW TIME** or **CW TIME**.

Hardware Configuration

- The controller must have mechanical relay, solid state relay or DC logic modules installed in the first two output sockets.

Refer to the section on Chapter 1 for more information.

Software Configuration

1. Go to **CONFIG.** menu.
Set **CTRL. TYPE** to **POS. PROP.**
2. Go to the **CONTROL** menu.
Set **P.P. TYPE** to **VELOCITY.**
3. Set **CCW TIME** to the amount of time (in seconds) it takes for the actuator to fully rotate in the counterclockwise direction.
Set **CW TIME** to the amount of time (in seconds) it takes for the actuator to fully rotate in the clockwise direction.
Loads on the valve may affect the time required, therefore, it is best to measure these values when the valve is in service. As an alternative, enter the values specified by the actuator manufacturer and then make adjustments later.
5. Set **MIN. TIME** to the minimum amount of time the controller must specify for the motor to be on before it takes any action.
6. Set values for **PV. BREAK**, **DES. OUTPT.**, **PWR.UP:OUT.** and **SHED OUT.**

F. STAGED OUTPUTS

With staged outputs, one analog output can vary its signal (e.g., 4-20 mA) over a portion of the PID output range. The second analog output then varies its signal over another portion of the PID output range. This is an excellent method to stage two control valves or two pumps using standard control signal ranges.

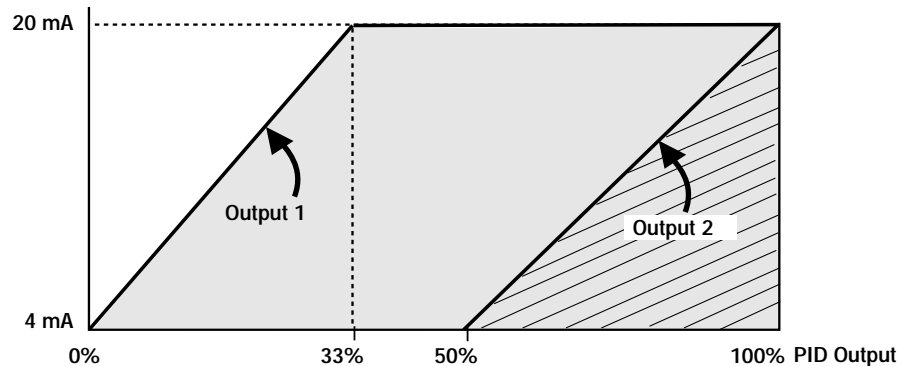

Figure 7.10
Staged Outputs Example
OUT1 STOP was set to 33% and
OUT2 STRT. was set to 50%.

Hardware Configuration

- The controller must have analog output modules installed in the first two output sockets.

Software Configuration

- Go to the **CONFIG.** menu.
Set **CTRL. TYPE** to STAGED.
- Go to the **CONTROL** menu.
- For **OUT1 STOP**, specify where the first output reaches 100%.
- For **OUT2 START**, specify where the second output begins.

G. RETRANSMISSION

The retransmission feature may be used to transmit a milliamp signal corresponding to the process variable, target setpoint, control output, or actual setpoint to another device. A common application is to use it to record one of these variables with a recorder.

NOTE: For an analog output module for retransmission that was not factory-installed, calibrate the output for maximum accuracy. Refer to Appendix 4 for details on calibration.

Hardware Configuration

- There must be an analog module installed in output socket 2, 3 or 4.

Software Configuration

Up to two outputs can be configured for retransmission. The menu will scroll through the configuration parameters for specified value "X" (2, 3 or 4).

- Go to the **CONFIG.** menu.
- For **OUTPUT:2**, **OUTPUT:3** and **OUTPUT:4** parameters, set one or two of them to RETRANS.
- Go to the **RETRANS.** menu.
- Set the corresponding parameter, **TYPE:X**, for the first retransmission output to define what is being transmitted: the process variable, setpoint, ramping setpoint or output.

5. Set parameters **LOW RANGE:X** and **HIGH RANGE:X** for the first retransmission output, to define the range of the transmitted signal in engineering units. This can be useful in matching the input range of the receiving device.
6. For any other retransmission output, continue to scroll through this menu and set the **TYPE:X**, **LOW RANGE:X** and **HIGH RANGE:X** for the second retransmission output.

H. DIGITAL INPUTS

Digital inputs can be activated in three ways: A switch (signal type)—the recommended type, a relay, or an open collector transistor.

Digital inputs are only functional when that option is installed (via hardware). The controller detects the hardware type, and supplies the appropriate software menus (see the section on parameters in Chapter 5). There are 14 contact types for the up to 5 digital inputs.

Hardware Configuration

- This optional feature is only available if ordered originally from the factory, Product #535xxxxxxDx00. The (up to) five digital inputs share a common ground.

Software Configuration

1. Go to the **CONFIG**. menu.
2. Set parameters **CONTACT:1** through **CONTACT:5** (only those available will shown) by assigning the desired function to each output. Choices are:

- SETPT 1-8

(For **CONTACT:1** only) Allows the controller to use the first four digital inputs to select a setpoint (see Figure 7.11). If the state of these inputs remains constant, the controller will continue to use the selected setpoint unless overridden. Override the set of digital inputs by selecting a different setpoint (by using **SET PT** key or through communications), or by using the fifth digital input to select the remote or 2nd setpoint. To “rearm” this set of digital inputs, the DIN combination must change.

Setpoints	DIN 1	DIN 2	DIN 3	DIN 4
SP	X	0	0	0
SP2	0	X	0	0
SP3	X	X	0	0
SP4	0	0	X	0
SP5	X	0	X	0
SP6	0	X	X	0
SP7	X	X	X	0
SP8	0	0	0	X

-

REM. SETPT.

Closing input changes active setpoint to remote setpoint. Opening reverts controller to previous setpoint. Override by selecting a different setpoint via the **SET PT** key, a communications command, or

NOTE: To take advantage of multiple setpoints, make sure that the **SP NUMBER** parameter in the **SPECIAL** menu is set to a value greater than 1.

Figure 7.11
Combinations of Closed Digital
Inputs for Each Setpoint (based on
BCD logic)

X=closed contact

0=open contact

- other digital inputs.
- **MANUAL**
Closing input trips the controller to manual. Opening input reverts controller to automatic. Override by using **MANUAL** key, a communications command, or “trip to automatic” function.
 - **2ND. SETPT.**
Closing input changes active setpoint to the 2nd local setpoint. Opening input reverts controller to previous setpoint digital input. Override by selecting a different setpoint via the **SET PT** key, a communications command, or other digital inputs.
 - **2ND. PID**
Closing input changes active set of PID values to 2nd set. Opening input bases active set of PID on rules defined in **PID TRIP** and **TRIP:1** to **TRIP:8**. Override input only by directly linking PID set to the active setpoint and changing the active setpoint.
 - **ALARM ACK.**
Closing input acknowledges all active alarms. Opening input “re-arms” the controller. If the digital input remains closed, it *does not* continue to immediately acknowledge alarms as they become active.
 - **RST. INHBT.**
Reset Inhibition. Closing input deactivates “I” (integral) term, regardless of the PID values being used. Opening input activates “I” term (if applicable).
 - **D.A./R.A.**
Direct Acting/Reverse Acting. Closing input reverses action of the first control output (from direct to reverse, or reverse to direct). Opening reinstates original action.
 - **STOP A/T**
Closing input temporarily disables Adaptive Tuning. Opening input enables it.
 - **LOCK. MAN.**
Closing contact places the controller in manual control at the designated output percentage. All locked manual contacts must be opened in order to return controller to automatic control.
 - **UP KEY / DOWN KEY**
Closing the contact mimics the designated ▲ or ▼ key. Useful if controller is mounted behind a window; contact push-buttons can be used to change setpoint values.
 - **DISP. KEY**
Closing contact mimics the **DISPLAY** key; scroll through display of the Setpoint, Deviation % and Output%.
 - **FAST KEY**
Closing contact mimics the **FAST** key . Use in conjunction with ▲, ▼, **DISPLAY** and **MENU** keys.
 - **MENU KEY**
Closing contact mimics the **MENU** key. In **OPERATION** Mode, provides entry to **TUNING** menu. In **SET UP** or **TUNING** Mode, ad-

NOTE: The second display does not change when tripping to manual from a closed digital input.

NOTE: Only alarms configured to be acknowledged are affected by this digital input.

vances through the menus.

- **COMM. ONLY**

Makes input status readable through communications (but has no effect on the controller itself).

- **PV2.SWITCH**

(only applicable for **PV SOURCE** = 1/2:SWITCH). Closing contact causes the 535 to use PV2 as the PV input (instead of PV1).

NOTE: There is a one-second delay before a closed digital input takes action.

Basic Operating Procedures

1. If more than one digital input closes and their actions conflict, the last digital input that closed has priority.

For example, if one digital input closes and selects 2nd setpoint, and then another digital input closes and selects a remote setpoint, the remote setpoint takes precedence.

2. Any digital input can be overridden by: another digital input, a keyboard operation, or an automatic function. If a closed digital input is overridden, then it must be opened in order to be rearmed.

For example, if one digital input closes and selects the 2nd setpoint, and then a different setpoint is selected through the keyboard, the keyboard selection takes precedence.

I. REMOTE SETPOINT

Remote setpoint limits are the same as setpoint limits.

Hardware Configuration

- The optional feature is available only if ordered originally from the factory, Product #535-xxxxxBxx00 or #535-xxxxxExx00). Refer to the order code in Chapter 1.
- Before configuring the software, make sure the corresponding jumper is set properly. Refer to Chapter 4 to check or change jumper positions.

Software Configuration

1. Go to the **REM. SETPT.** menu.
2. **RSP TYPE** defines the input signal range (e.g. 4-20 mA).
3. **RSP:LO.RNG.** and **RSP:HI.RNG.** define the range of the remote setpoint in engineering units. The correct range will be dependent on the source of the remote setpoint signal.
4. **RSP:LOW** and **RSP:HIGH** set limits on the remote setpoint value in engineering units.
5. **TRACKING** determines whether or not the controller will revert to a local setpoint if the remote setpoint signal is lost. This prevents a process upset due to a sudden change in setpoint.
6. **BIAS LOW** and **BIAS HIGH** set limits on an operator entered bias value.
7. **RSP FIXED** determines the signal to which the controller will revert when a lost RSP is restored (fixed). Options are to stay in local or automatically return to remote setpoint.
8. To bias or ratio the remote setpoint value:
 - a. Go to the **TUNING** menu.
 - b. Set **RSP BIAS** and **RSP RATIO** values.

Basic Operating Procedures

After configuring the hardware and software, select the remote input by:

- pressing the **SET PT** key until **RSP** shows in the display
- using a digital input

J. MULTIPLE SETPOINTS

The 535 can store up to eight local setpoints and use a remote setpoint. One application of this feature is configuring the controller to restrict operators to discrete setpoint choices. The 535 can also store multiple sets of PID parameters (see next section).

Software Configuration

1. Go to the **SPECIAL** menu.
2. Set **NO. OF SP** to the number of local setpoints desired.
3. Use the **SET PT** key to scroll to each local setpoint and set it to the desired value with the **▲** or **▼** keys.
4. To link the PID sets to the corresponding local setpoint:
Go to the **TUNING** menu.
Set **NO. OF PID** to SP NUMBER.
For details on multiple sets of PID, refer to the next section in this chapter.

Basic Operating Procedures

To select a set point, toggle the **SET PT** key to scroll through the setpoints. The displayed setpoint becomes active after two second of key inactivity.

The digital inputs can also be used to select the active setpoints. A single digital input may be used for selecting the second setpoint, SP2. A set of four digital inputs may be used, to select up to 8 setpoints (see the section in this Chapter on Digital Inputs).

The **SET PT** key is lit when a setpoint other than the primary local setpoint is active.

K. MULTIPLE SETS OF PID VALUES

The 535 has the ability to store up to eight sets of PID values. This can be a valuable feature for operating the controller under conditions which require different tuning parameters for optimal control. There are various methods of selecting which set should be active. These methods are explained in this section.

Software Configuration

1. Go to the **TUNING** menu.
2. **NO.OF PID** is the desired number of PID sets to be stored. **SP VALUE** automatically sets this value equal to the number of stored local setpoints (each PID set will be active when its respective local setpoint is active).
3. **PID TRIP** determines which variable selects the various PID sets: process variable, setpoint or deviation from setpoint.
4. **TRIP:X** defines the point (in the PV range) at which that set of PID values become active.

Basic Operating Procedures

A PID set can be selected in one of four ways.

- For **NO. OF PID** = PV NUMBER, the PID set (1 or 2) is selected when PV1 or PV2 is used.
- For **NO. OF PID** = SP NUMBER, the active set of PID values is the same as the active setpoint. For example, if SP3 is active, then PID set #3 will be active.
- When using PID trip values, a PID set becomes active when the variable exceeds its trip point.
For example, if **PID TRIP** = SETPOINT, and **TRIP:2** = 500, the second set of PID values becomes active when the setpoint exceeds 500, and remains active until the setpoint drops below 500 or exceeds the next highest trip point. The PID set with the lowest trip point is also active when the trip variable is less than the trip value. (The user can set the lowest trip point = the low end of the process variable range, but this is not required.)
- A digital input can be set to trip to the second set of PID upon closure, which overrides a selection based on trip points.

Using with Adaptive and Pretune

The 535 can be programmed to automatically set the PID values using the Pretune and Adaptive Tuning functions. For both functions, the tuned set of PID is that which is active upon initiation of the tuning function.

The controller cannot trip to other PID sets (based on trip point or the digital input contact) until Adaptive Tuning is disabled. However, if the PID set is tied to the corresponding local setpoint, the active PID set values will change with the local setpoint.

Each PID set has 5 parameters that control its function—proportional band, reset, rate, manual reset (or loadline), and trip point. For each set (2 thru 8), these values have to be manually set.

1. Press **MENU** to access the **TUNING** menu.
2. Set values for parameters 1 thru 20 (these include the first PID set)
3. Press **MENU** to access these parameters for each additional PID set (2 through 8): **PROP. BND**, **RESET**, **RATE**, **MAN. RST.** and **TRIP**.

L. POWERBACK

POWERBACK is a proprietary algorithm which, when invoked by the user, reduces or eliminates setpoint overshoot at power up or after setpoint changes. Powerback monitors the process variable to make predictive adjustments to control parameters, which in turn helps to eliminate overshoot of the Setpoint.

Software Configuration

1. Go to the **TUNING** menu.
2. Set **POWR.BACK** parameter to **ENABLED**.
3. Go to the **SELF TUNE** menu.
4. For **DEAD TIME**, set the value (time) that the controller should wait before invoking an output change. This value is typically the dead time of the process. Or, let Pretune calculate the dead time, then complete just steps 1 and 2 above.

M. SELF TUNE—POWERTUNE®

The Self Tune function of the 535 consists of two distinct components, Pretune and Adaptive Tune. These components may be used independently or in conjunction with one another. For best results, we recommend using them together.

Pretune

This algorithm has three versions. Choose the type that most closely matches the process to optimize the calculation of the PID parameters. The three Pretune types are:

- TYPE 1 Normally used for slow thermal processes
- TYPE 2 Normally used for fast fluid or pressure processes
- TYPE 3 Normally used for level control applications

Pretune is an on-demand function. Upon initiation, there is a five second period during which the controller monitors the activity of the process variable. Then the control output is manipulated and the response of the process variable is monitored. From this information, the initial Proportional Band, Reset and Rate (P, I and D values) and dead time are calculated. When using TYPE 2 or TYPE 3 Pretune, the Noise Band (**NOISE BND.**) and Response Time (**RESP. TIME**) will also be calculated.

In order to run this algorithm, the process must fulfill these requirements:

- The process must be stable with the output in the manual mode;
- For tuning a non-integrating process, the process must be able to reach a stabilization point after a manual step change; and
- The process should not be subject to load changes while Pretune operates.

If these conditions are not fulfilled, set the Adaptive Tune to run by itself.

Adaptive Tune

Adaptive Tune continuously monitors the process and natural disturbances and makes adjustments in the tuning parameters to compensate for these changes. In order to make accurate calculations, Adaptive Tune needs noise band and response time values. Pretune TYPE 2 and TYPE 3 automatically calculate these values. These values may also be entered or changed manually in the **SELF TUNE** menu. For Pretune TYPE 1, Noise Band and Response Time parameters must be entered manually.

Figure 7.12 illustrates the relationship between Pretune and Adaptive Tune

Software Configurations

Pretune by Itself

1. Go to the **SELF TUNE** menu (press **MENU+FAST**)
2. Set the **TYPE** parameter to **PRETUNE**.
3. Set the **PRETUNE** type to the one that best matches the process (see above section).
4. The next parameter, **TUNE PT.**, appears only for TYPE 1 pretune. This parameter sets the PV point at which the output will switch off. In thermal processes, this will help prevent overshoot. The default is **AUTOMATIC**.

CAUTION!

Disable Adaptive Tuning before altering process conditions (e.g., for shutdown, tank draining, etc.). Otherwise, the 535 will attempt to adapt the Tuning parameters to the temporary process conditions.

Adaptive Tune can be disabled via digital input (if applicable—see Digital Inputs in this chapter), or via menus:

1. Go to the **TUNING** menu.
2. Go to parameter **ADAPTIVE**.
Change the value to **DISABLED**.

- Set the value for **OUT STEP**. This parameter defines the size of bump to be used. The resulting disturbance must change the process variable by an amount that significantly exceeds the peak-to-peak process noise, but does not travel beyond the “normal” process variable range.
- The next two parameters, **LOW LIMIT** and **HI LIMIT**, set the process variable boundaries. If these boundaries are exceeded during the Pretune, the pretune cycle will abort and return to manual control at the output level prior to the initiation of pretune.

Figure 7.12
Pretune TYPE 1, 2 and
3 with Adaptive Tune

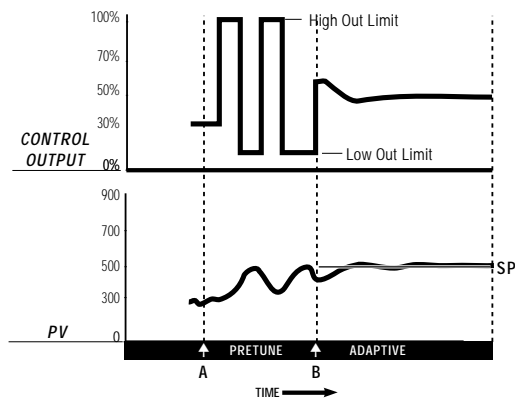

TYPE 1 Pretune/Adaptive Control

- A to B is ON/OFF control to determine initial PID values.
- B is Pretune completed, so Adaptive PID control begins if ENABLED.

Note: Noise Band and Resp. Time must be entered before enabling Adaptive Tune)

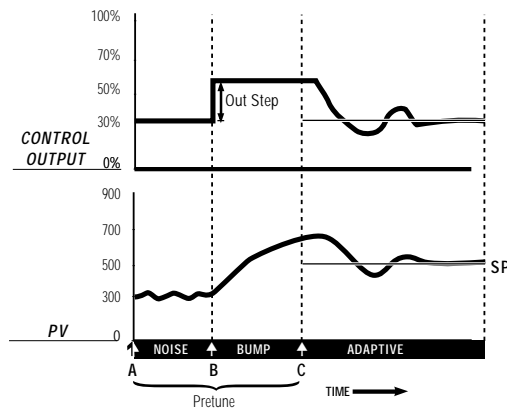

TYPE 2 Pretune/Adaptive Control

- A to B is a 5 second noise band measurement.
- B to C is an open loop bump test to determine initial PID values and response time.
- C is Pretune completed, so Adaptive PID control begins if ENABLED.

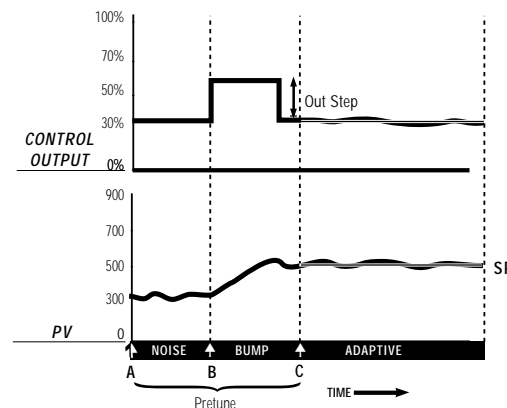

TYPE 3 Pretune/Adaptive Control

- A to B is a 5 second noise band measurement.
- B to C is an impulse to determine initial PID values and response time.
- C is Pretune completed, so Adaptive PID control begins if ENABLED.

7. The next parameter, **TIMEOUT**, defines the maximum time in minutes within which pretune must complete its calculations before it is aborted.
The first time a pretune is performed, set **TIMEOUT** to its maximum value. Make note of the length of the pretune cycle. Then, adjust **TIMEOUT** to a value about twice the pretune time.
The purpose of this parameter is to prevent a Pretune cycle from continuing for an excessive time if a problem develops. The value has no impact on the PID values being calculated.
8. Next is **MODE**. This defines what mode the controller will enter when pretune is completed. Select MANUAL if there will be a need to review PID parameters before attempting to control with them; the default AUTOMATIC.
9. **RESP. TIME** defines the amount of damping for the process. The choices include FAST (results in approximately 20% overshoot), MEDIUM (results in approximately 10% overshoot), and SLOW (<1%).
10. Place the controller under manual control.
11. Access the **TUNING** menu (press **MENU**).
Set the first parameter, **ADAPTIVE**, to DISABLED.
12. Activate the next parameter, **PRETUNE**.
13. Press **ACK** to begin Pretuning.
The 3rd display will show the message EXECUTING.
14. When Pretune is complete, the 3rd display will show COMPLETED for two seconds and then return to the current menu display.

Pretune TYPE 1 & Adaptive Tune

1. Go to the **SELF TUNE** menu.
2. Set **TYPE** to BOTH.
3. Set **PRETUNE** to TYPE 1.
4. Set a value for **OUTSTEP**.
5. Set **NOISE BND** parameter.
6. Set the **RESP. TIME** parameter.
7. Make sure that the process is reasonably stable and place the controller under manual control.
8. Press **MENU** to access the **TUNING** menu.
Set **ADAPTIVE** to ENABLED. The Adaptive Tuning cycle does not begin the controller is under automatic control.
9. Activate the next parameter, **PRETUNE**.
10. Press **ACK** to begin Pretuning.
The 3rd display will show the message EXECUTING.
11. When Pretune is complete, the 3rd display will show COMPLETED for two seconds and then return to the current menu display.

The controller will automatically transfer to automatic control upon completion of Pretune if set to do so, or upon manual transfer.

Figure 7.12 illustrates the operation of Pretune TYPE 1 with Adaptive Tune.

Pretune TYPE 2 or 3 & Adaptive Tune

1. Go to the **SELF TUNE** menu.
2. Set the **TYPE** parameter to BOTH.

NOTE: Adaptive tuning is **not** available for velocity position proportional control.

3. Set the **PRETUNE** parameter to TYPE 2 or TYPE 3.
4. **DO NOT** Enter values for **NOISE BND** and **RESP TIME**. The Pretune algorithm will calculate these values.
2. Make sure that the process is reasonably stable and place the controller under manual control.
3. Press **MENU** to access the **TUNING** menu.
4. Set parameter **ADAPTIVE** to **ENABLED**. The Adaptive Tuning cycle does not begin. The controller is under automatic control.
4. Activate the next parameter, **PRETUNE**.
5. Press **ACK** to begin Pretuning.
The 3rd display will show the message **EXECUTING**.
6. When Pretune is complete, the 3rd display will show **COMPLETED** for two seconds and then return to the current menu display.

The controller will automatically transfer to automatic control upon completion of Pretune if set to do so, or upon manual transfer.

Figure 7.12 illustrates the operation of Pretunes TYPE 2 and TYPE 3 with Adaptive Tune.

CAUTION!

If the process conditions are temporarily changed, (e.g., during process shutdown, draining of a tank, etc.) **disable adaptive tuning**.

Otherwise, the controller will attempt to adapt its tuning parameters to the temporary process conditions.

Disable adaptive tuning by:

1. In the **TUNING** menu, change **ADAPTIVE** to **DISABLED** through the keypad; or
2. Closing the appropriate digital input (see Digital Input section in this chapter).

Adaptive Tune by Itself

1. Go to the **SELF TUNE** menu.
2. Set the **TYPE** parameter to **ADAPTIVE**.
3. Press **MENU** to access the **TUNING** menu.
4. Set the **ADAPTIVE** parameter to **ENABLED**. The Adaptive Tuning cycle does not begin. The controller is under automatic control.

If Pretune results are poor or process conditions do not allow Pretune to run, the Adaptive Tune parameters can be manually configured. Proper setting of the noise band and response time parameters will yield excellent adaptive control without running the Pretune function.

1. Go to the **SELF TUNE** menu.
2. Set **NOISE BND**.

The noise band is chosen to distinguish between disturbances which affect the process and process variable “noise.” The controller functions to compensate for disturbances (i.e., load changes), but it cannot compensate

Figure 7.13
Noise Band Calculation Example

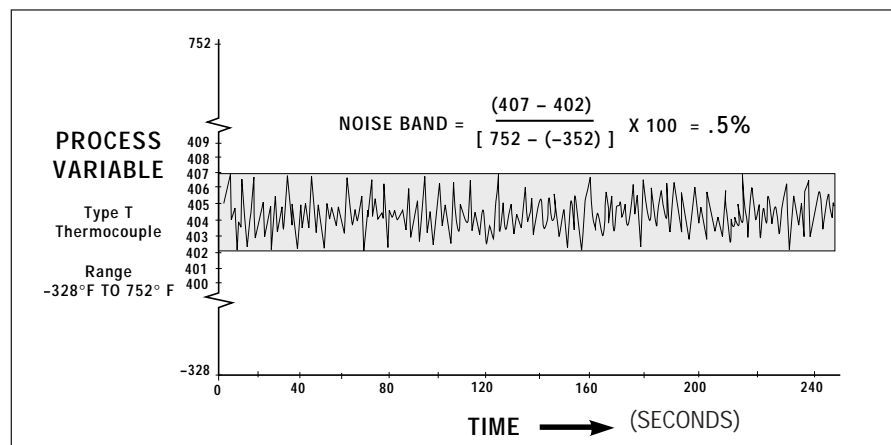

for process noise. Attempting to do this will result in degraded controller performance. The Noise Band is the distance the process deviates from the setpoint due to noise in percentage of full scale.

Figure 7.13 shows a typical process variable response in a steady-state situation. In this example, the process noise is within a band of about 0.5% of full scale.

A noise band that is too small will result in tuning parameter values based on noise rather than the effects of load (and setpoint) changes. If the noise band is set too small, then Adaptive Tune will attempt to retune the controller too often. This may result in the controller tuning cycling between desirable system tuning and overly sluggish tuning. While the result may be better than that achieved with a non-adaptive controller, this frequent retuning is not desirable.

If the noise band is set too large, the process variable will remain within the noise band, and the controller will not retune itself. With too large a noise band, important disturbances will be ignored, and the controller will be indifferent to sluggish and oscillatory behavior.

Noise band settings are generally between 0.1% and 1.0%, with most common settings of 0.2% or 0.3%. Figure 7.14 shows the conversion of peak-to-peak noise to an appropriate noise band for each T/C type & RTD.

		INPUT TYPE											
		B	E	J	K	N	R/S	T	W/WS	PLATINEL	RTD	0.1°RTD	
Peak to Peak Noise °F	0	0.1	0.1	0.1	0.1	0.1	0.1	0.1	0.1	0.1	0.1	0.1	0.1
	1	0.1	0.1	0.1	0.1	0.1	0.1	0.1	0.1	0.1	0.1	0.1	0.1
	2	0.1	0.1	0.1	0.1	0.1	0.1	0.2	0.1	0.1	0.1	0.1	0.2
	3	0.1	0.2	0.2	0.1	0.1	0.1	0.3	0.1	0.2	0.2	0.2	0.3
	4	0.1	0.2	0.2	0.1	0.1	0.1	0.4	0.1	0.2	0.2	0.2	0.5
	5	0.2	0.2	0.2	0.2	0.2	0.2	0.5	0.1	0.2	0.3	0.3	0.6
	6	0.2	0.3	0.3	0.2	0.2	0.2	0.6	0.1	0.3	0.3	0.3	0.7
	7	0.2	0.3	0.3	0.2	0.3	0.2	0.6	0.2	0.3	0.4	0.4	0.8
	8	0.2	0.4	0.4	0.3	0.3	0.3	0.7	0.2	0.4	0.4	0.4	0.9
	9	0.3	0.4	0.4	0.3	0.3	0.3	0.8	0.2	0.4	0.5	0.5	1.0
	10	0.3	0.4	0.4	0.3	0.4	0.3	0.9	0.2	0.4	0.5	0.5	1.1

Figure 7.14
Noise Band Values for
Temperature Inputs

3. Set RESP. TIME.

The response time is the most critical value in Adaptive Tuning. Response time represents the time lag from a change in valve position (controller output) to a specific amount of change in process variable. Specifically, Response Time is equal to the Deadtime of the process plus one Time Constant. The Deadtime is the time between initiation of an input change and the start of an observable response in the process variable. The Time Constant is the interval of time between the start of that observable response and the point where the process variable reaches 63% of its final value. (See Figure 7.15).

Example

After a stimulus (e.g., valve movement), if it takes 300 seconds for a process to reach 63% of its new (expected) value, the response time is 300 seconds. If the response time is set too short, the process will be unstable and cycle

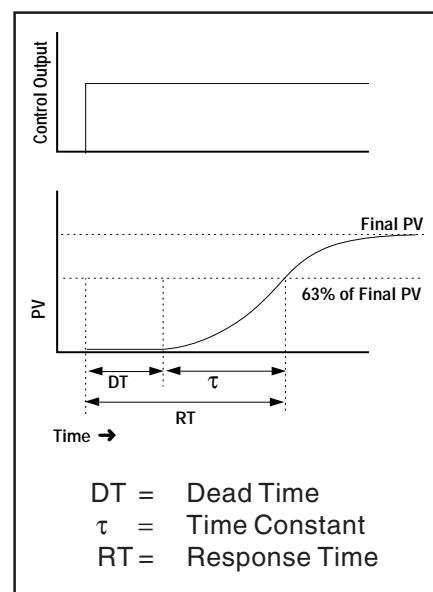

Figure 7.15
Deadtime and Time Constant

around the setpoint. If the Response Time is set too long, response to an off-setpoint condition will be sluggish. It is generally better to use too long a response time than too short.

Self Tuning with Multiple Sets of PID

For both Pretune and Adaptive Tune, the tuned set of PID is that which is active upon initiation of the tuning function.

The controller cannot trip to other PID sets (based on trip point or the digital input contact) until Adaptive Tuning is disabled. However, if the PID set is tied to the corresponding local setpoint, the active PID set values will change with the local setpoint.

Each PID set has 5 parameters that control its function—proportional band, reset, rate, manual reset (or loadline), and trip point. For each set (2 thru 8), these values have to be manually set.

1. Press **MENU** to access the **TUNING** menu.
2. Set values for parameters 1 thru 20 (these include the first PID set).
3. Press **MENU** to access these parameters for each additional PID set (2 through 8): **PROP. BND**, **RESET**, **RATE**, **MAN. RST.** and **TRIP**.

Self Tune with Time Proportioning Outputs

When using either the Pretune or the Adaptive Tune with a time proportioning output, use as short of a cycle time as possible within the constraint of maintaining a reasonable life on relays, contacts or heating elements.

Self Tune with Control Valves

In many systems utilizing a control valve, the point at which the control valve begins to stroke does not coincide with 0% output, and the point at which it completes its stroke doesn't coincide with 100%. The parameters **LOW OUT** and **HIGH OUT** in the **CONTROL** menu specify the limits on the output. Set these limits to correspond with the starting and stopping point of the valve's stroke. This prevents a form of "windup" and thus provides the adaptive control algorithm with the most accurate information.

For example, in manual the control output was slowly increased and it was noted that the control valve started to stroke at 18% and at 91% it completed its stroke. In this case **LOW OUT** should be set at 18% and **HIGH OUT** at 91%.

Note that when output limits are used, the full output range from -5 to 105% is available in manual control.

N. RAMP-TO-SETPOINT

The 535 contains a ramp-to-setpoint function that may be used at the user's discretion. This function is especially useful in processes where the rate-of-change of the setpoint must be limited.

When the ramping function is activated, the controller internally establishes a series of setpoints between the original setpoint and the new **target** setpoint. These interim setpoints are referred to as the **actual** setpoint. Either setpoint may be viewed by the user. When the setpoint is ramping, **RAMPING** will be shown in the 3rd display when the actual (ramping) setpoint is displayed.

When the target setpoint is being shown, RAMPING will **not** appear. Pressing the **DISPLAY** key will scroll the 2nd display as follows:

- From the target setpoint to the actual (ramping) setpoint;
- To the deviation from setpoint;
- To the output level; and
- Back to the target setpoint.

Note that when ramping, the deviation indication is with respect to the target setpoint.

The ramp-to-setpoint function is triggered by one of three conditions:

1. Upon power up, if the 535 powers up in automatic control, then the setpoint will ramp from the process variable value to the setpoint value at the specified rate.
2. On a transfer from manual to automatic control the setpoint will ramp from the process variable value to the setpoint value at the specified rate.
3. On any setpoint change, the setpoint will ramp from the current setpoint to the new target setpoint. When triggered, the display will automatically change to indicate the ramping setpoint.

Software Configuration

1. Go to the **PV INPUT** menu.
2. Set the **SP RAMP** parameter to the desired rate of change.

O. INPUT LINEARIZATION

Thermocouple and RTD Linearization

For a thermocouple or RTD input, the incoming signal is automatically linearized. The 535 has lookup tables that it uses to provide an accurate reading of the temperature being sensed.

Square Root Linearization

Many flow transmitters generate a nonlinear signal corresponding to the flow being measured. To linearize this signal for use by the 535, the square root of

$$PV = \text{Low Range} + \left[(\text{Hi Range} - \text{Low Range}) \sqrt{(V_{\text{input}} - V_{\text{low}}) / (V_{\text{high}} - V_{\text{low}})} \right]$$

Hi Range is the high end of the process variable.

Low Range is the low end of the process variable.

V_{input} is the actual voltage or current value of the input.

V_{high} is the high end of the input signal range (e.g. 5 volts or 20 mA).

V_{low} is the low end of the input signal range (e.g. 1 volt or 4 mA).

Example:

PV range is 0 – 1000.

Input signal range is 1–5 volts.

Input signal is 3 volts.

Therefore $PV = 0 + \left[(1000 - 0) \sqrt{(3-1) / (5-1)} \right] = 1000\sqrt{.5} = 707$

*Figure 7.16
Square Root Linearization Formula*

the signal must be calculated. The 535 has the capability to perform this square root linearization.

For the first 1% of the input span, the input is treated in a linear fashion. Then it is a calculated value, using the formula in Figure 7.16.

Hardware Configuration

- A voltage or milliamp input must be installed on the controller.

Software Configuration

1. Go to the **PV INPUT** menu.
2. Set **LINEARIZE** to **SQR. ROOT**.

Custom Linearization

Custom linearization allows virtually any nonlinear signal to be linearized using a 15-point straight line approximation curve (see Figure 7.17). Typical

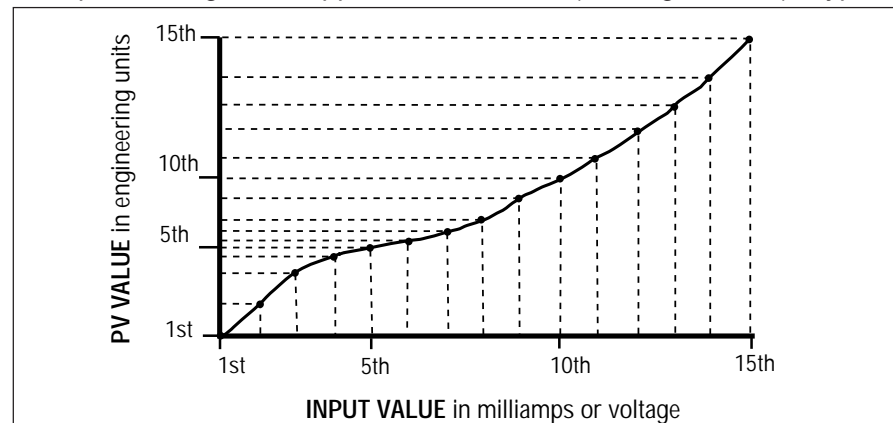

Figure 7.17
15-point Linearization Curve

applications are linearizing signals from nonlinear transducers, or controlling volume based on level readings for irregularly-shaped vessels. To define the function, enter data point pairs—the engineering units corresponding to a particular voltage or current input.

Software Configuration

1. Go to the **PV INPUT** menu.
2. Set the parameter **LINEARIZE** to **CUSTOM**.
3. Go to the **CUST. LINR.** menu.
4. Enter values for the **1ST INPUT** and **1ST PV** data points. All the input parameters define the actual milliamp or voltage input. All the PV parameters define the corresponding process variable value in engineering units.

It is not necessary to use all 15 points. Whenever the **XTH INPUT** becomes the high end of the input range, that will be the last point in the table.

Once the various points are defined, the values between the points are

interpolated using a straight line relationship between the points. The only limitation is that the resulting linearization curve must be either ever-increasing or ever-decreasing.

P. LOAD LINE

Load line is a manual reset superimposed on the automatic reset action. Adjusting the **MAN. RST.** tuning constant shifts the controller proportional band

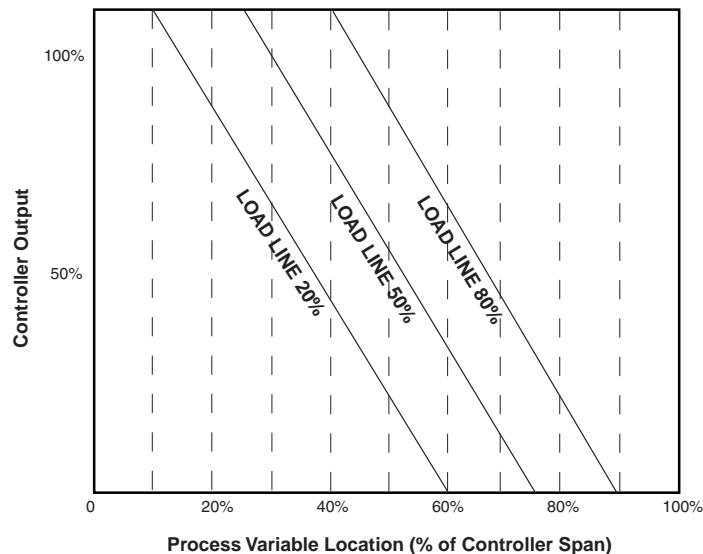

Figure 7.18
Load Line Example

with respect to the setpoint.

When used with a proportional only or proportional/derivative control algorithm, the **MAN. RST.** parameter (located in the **TUNING** menu) is in effect “manual reset”.

However, when the automatic reset term is present, the reset action gradually shifts the proportional band to eliminate offset between the setpoint and the process. In this case, load line provides an initial shift at which the reset action begins. Load line is adjusted by observing the percent output required to control the process and then adjusting the load line to that value. This minimizes the effect of momentary power outages and transients. Load line may also be adjusted to give the best response when bringing the load to the desired level from a “cold” start.

Q. SECURITY

The 535 security system is easily customized to fit a system’s needs.

Software Configuration

1. Go to the **SECURITY** menu.
2. **SEC. CODE** defines the security password (range from -9999 to 99999). The rest of the security parameters can be selectively locked out.
3. **SP ADJUST** prevents the operator from using the ▲ and ▼ and keys to change the setpoint value. It does not prevent the operator from changing setpoints via the **SET PT** key.
4. **AUTO./MAN.** locks out the **MANUAL** key preventing the operator from transferring between automatic control and manual control.

NOTE: **SEC CODE** does not appear unless all functions are unlocked.

NOTE: Lock out **CONFIGURE** for full security. If left unlocked, the operator will have access to the security code.

NOTE: The security function is compromised if the security code is left at zero (0).

NOTE: Security does not prevent the operation from the digital inputs or serial communications.

5. **SP SELECT** locks out the **SET PT** key. This prevents the operator from changing among the various local setpoints or changing to remote setpoint. It does not prevent the operator from changing the setpoint value via the ▲ and ▼ keys.
6. **ALARM ACK.** locks out the **ACK** key, preventing an operator from acknowledging any alarms.
7. **TUNING** locks out modification to the parameters in the **TUNING** menu, preventing unauthorized changes to the tuning parameters or the activation/deactivation of the self tuning algorithm.
8. **CONFIGURE** allows access to the configuration menus, but prevents any unauthorized changes to the configuration parameters. If locked out, the security code is not accessible.

Basic Operating Procedures

The security feature can be overridden. When a locked function is attempted, the operator will have the opportunity to enter the security code. **If the correct security code is entered, the operator has full access. The security feature is reactivated after one minute of keypad inactivity.** If the security code is forgotten, the security feature can still be overridden.

- Please contact Moore Industries to obtain the security override code.

Once you obtain security override code, make sure to save it and store in a secure location and limit access.

R. RESET INHIBITION

Reset Inhibition is useful in some systems either at the start-up of a process or when a sustained offset of process variable from setpoint exists. In conditions like these, the continuous error signal may cause the process temperature to greatly overshoot setpoint. Any of the digital inputs may be set up so that the contact closure disables the reset action (sets it to zero).

Software Configuration

1. Go to the **CONFIG.** menu.
2. Set corresponding parameter(s) **CONTACT:1** to **CONTACT:5** to RST. INHBT.

S. PROCESS VARIABLE READING CORRECTION

Conditions extraneous to the controller, an aging thermocouple, out of calibration transmitter, lead wire resistance, etc.—can cause the display to indicate a value other than the actual process value. The PV OFFSET and PV GAIN parameters can be used to compensate for these extraneous conditions. **NOTE:** This feature is provided as a convenience only. Correcting the cause of the erroneous reading is recommended.

1. Go to the **PV INPUT** menu.
2. Set **PV OFFSET.** This parameter either adds or subtracts a set value from the process variable reading in engineering units. For example, if the thermocouple was always reading 3° too high, the parameter could be set to “-3” to compensate.
3. Set **PV GAIN.** This multiplies the deviation from the low end of the process variable range by the gain factor and then adds it to the value of the low end

NOTE: **PV GAIN** is only available if using a linear voltage or current input.

of the range to arrive at the adjusted process variable value.

For example, if the process variable range is 50 to 650 and the process variable reading is 472, a **PV GAIN** of .995 would yield an adjusted process variable equal to $[(472 - 50) \times .995] + 50 = 470$.

With a combination of both offset and gain factors, just about any inaccuracy in the sensor or transmitter can be compensated.

T. SERIAL COMMUNICATIONS

The serial communications option enables the 535 to communicate with a supervisory device, such as a personal computer or programmable logic controller.

The communications standard utilized is RS-485 which provides a multi-drop system that communicates at a high rate over long distances. Typical limitations are 32 instruments per pair of wires over a distance up to 4000 feet.

The 535 uses a proprietary protocol which provides an extremely fast and accurate response to any command. Cyclic redundancy checking (CRC) virtually ensures the integrity of any data read by the 535. Through communications, there is access to every Set up, Tuning and Operating parameter. For details on the 535 protocol, contact a Moore Industries application engineer.

Hardware Configuration

- This optional feature is only available if ordered originally from the factory. The circuitry for communications is contained on a modular circuit board that plugs into the Microcontroller Circuit Board, Refer to the order code in Chapter 1 for details.

Software Configuration

1. Access the **SER. COMM.** menu.
2. **STATION** specifies the unit's station address. It is the only way one 535 can be distinguished from another. Each 535 on the same RS-485 interface must have a unique station address.
3. Choose a **BAUD RATE** from 1,200 to 19,200. In general, select the highest value. However, every instrument on the RS-485 interface must be set to the same baud rate.
4. **CRC** indicates the cyclic redundancy checking feature. If the host supports it, activating this option is recommended.
5. When the 535 senses that communications is lost, it can go to a predetermined state (called "shedding"). The **SHED TIME** parameter sets the length of time that communications can be interrupted before the controller sheds. Since the 535 is a stand-alone controller, it does not depend on communications to operate. Therefore, if the "shed" feature is not needed, set it to OFF.
6. **SHED MODE** designates the mode to which the controller goes after it sheds. Setting this to **MANUAL** brings up the following parameters.
7. Use **SHED OUT** to specify an output level if the unit sheds and trips to manual control.
8. To specify a control setpoint (in case the host is supervising the setpoint) if the 535 sheds, Set **SHED SP** to **DESIG. SP** and then, set the parameter

DESIG. SP to the desired setpoint.

U. CASCADE CONTROL

While a single 535 Controller is effective in maintaining many control systems, others require more sophisticated control schemes. Figure 7.19, shows a sample control set up with a 535 controller. Cascade control is often used to control a process more precisely. In cascade control, a second variable is monitored in addition to the primary controlled variable. This second variable is one that more quickly reflects any changes in the process environment.

Cascade control involves installing one feedback loop within another, as in Figure 7.20. This second loop, based on steam pressure, is called the inner or secondary feedback loop. The outer or primary feedback loop is based on the temperature of the liquid in the heat exchanger. However, instead of directly positioning the steam valve, the output of the primary 535 controller is now used to adjust the setpoint of the secondary 535 controller, which then positions the valve.

Cascade Control is typically used for the following:

- A slow responding process with a significant lag time
- A process requiring more advanced or tighter control
- A process where two PID control loops need to interact to achieve optimum control. Cascade control is commonly implemented in temperature control applications where the main control variable is affected by another variable, i.e., pressure.

Example

In Figure 7.19 we have a 535 set up to control a heat exchanger. In a PID-equipped heat exchanger, pressure in the steam shell more quickly reflects fluctuations in the steam supply than does the process liquid's temperature.

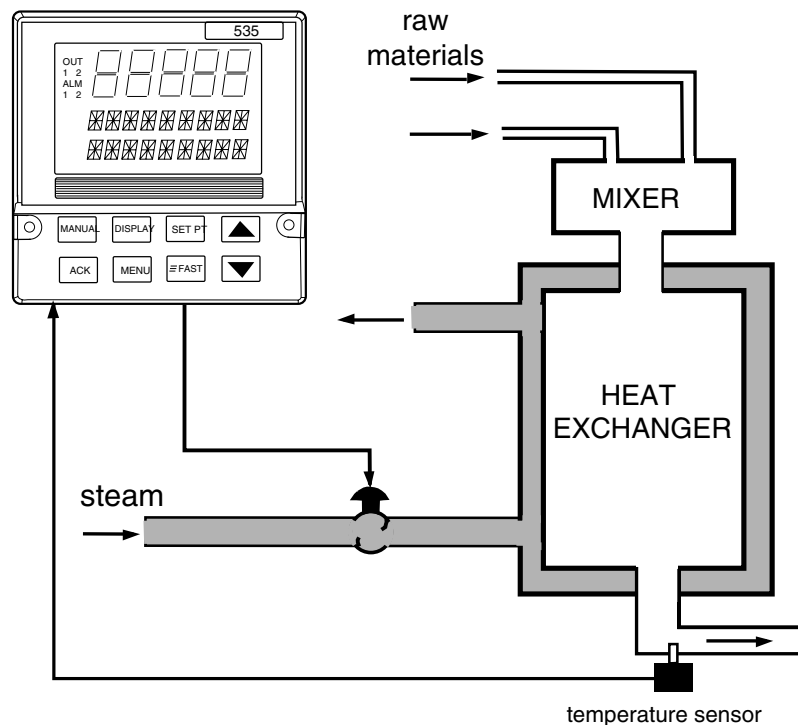

Figure 7.19
Heat Exchanger Control Loop for
Steam Supply

Why? In this example, with PID control, the average temperature of the liquid in the heat exchanger is 80°, but can vary by as much as five degrees because the steam supply itself is not constant. Fluctuations in the pressure of the steam supply cause fluctuations in the temperature of the steam within the heat exchanger. So, the process liquid's temperature begins to rise, but it takes several minutes for the increased heat from the steam to travel through the process liquid to reach the temperature sensor. By the time the sensor registers the higher value and calls for a decrease in steam, the process liquid near the walls is already at an even higher temperature. Although the steam supply is reduced, the process liquid's temperature continues to rise for a period of time. This delay in the transfer of heat prevents the 535 controller from controlling the temperature more precisely.

The solution to the problem is illustrated in Figure 7.20. Have the PID controller position the steam valve, but add a sensor by means of another 535 controller

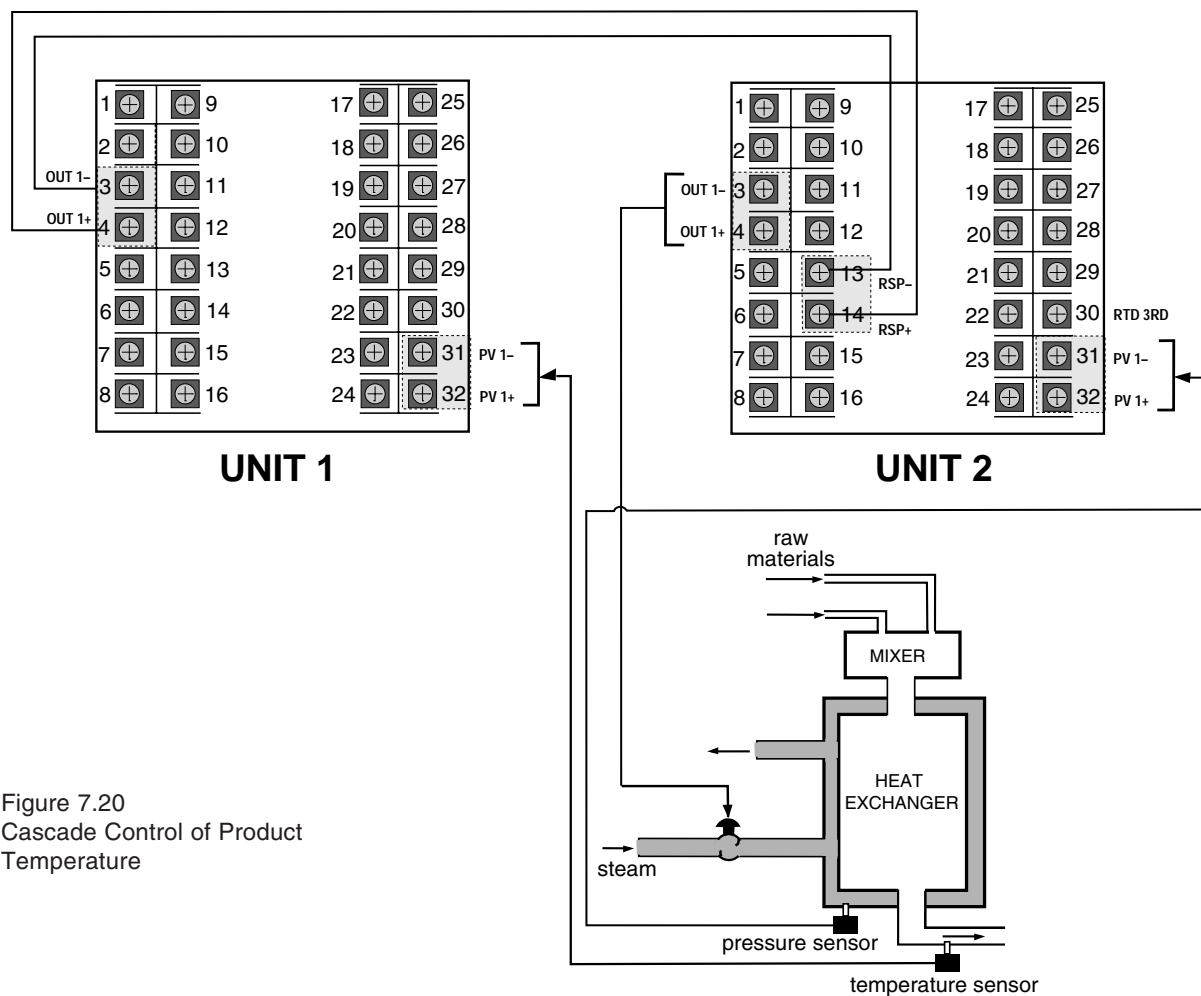

Figure 7.20
Cascade Control of Product
Temperature

that will monitor the steam pressure. The pressure control system now creates a second feedback control loop, which “cascades” from the first.

Hardware Configuration

- Configure Unit 1 for a 4-20mA output (analog module for control).

- Configure Unit 2 for the optional Remote Setpoint (see Chapter 4).

Software Configuration

1. For Unit #1
 - a. In **CONFIG.** menu, set **CTRL. TYPE** to STANDARD.
 - b. In **PV INPUT** menu, set the **PV TYPE** parameter.
If type is V/mA, set **LOW RANGE** and **HI RANGE** parameters to match the transmitter range.
2. For Unit #2
 - a. Set the RSP input jumper in the **mA** position on the Microcontroller Circuit Board (see Chapter 4).
 - b. Go to the **REM. SETPT** menu.
 - c. Set **RSP:LO. RNG.** to 0. Set **RSP:HI.RNG.** to 100. This will set the range of the remote setpoint to 0 TO 100 (to correspond to the 0% to 100% output range of Unit #1).
 - d. Wire the control output of Unit #1 to the remote setpoint input of Unit #2 as shown in Figure 7.20.
 - e. When in operation, Unit #2 must be under remote setpoint control.

Tuning Cascade Control

1. The secondary loop is controlled by Unit #2, which does most of the work in controlling the process. Put the secondary loop/Unit #2 under Manual control, and perform a Pretune on it. Once that Pretune is completed, put the Unit #2 under Automatic control.
2. The primary loop is controlled by Unit #1, which controls disturbances or load changes in the process. Now place the primary loop/Unit #1 into Manual and perform a Pretune on this loop. Once this Pretune is complete, the Cascade Control Loop is completely tuned. Place Unit #1 into Automatic control to allow the system to control to the desired Setpoint of the Primary loop.

V. RATIO CONTROL

Ratio Control is employed in mixing applications that require the materials to be mixed to a desired ratio.

For example: A given process requires Material A to be blended with Material B in a 2:1 ratio. Material B is uncontrolled or wild. Flow sensors/transmitters are used to measure the flow rate of each stream. The flow signal for Material A is wired to the process variable input, and the flow signal for Material B is wired to the remote setpoint input of the 535.

For this example, as shown in Figure 7.21, we would set **RSP RATIO** to 2.0. If the flow of Material B is measured at 50 gallons/minute, the effective remote setpoint value would be 2 times 50, or 100. The 535 controller would try to maintain the flow of Material A at 100. As the flow of Material B changes, the setpoint would change accordingly, always in a 2:1 ratio.

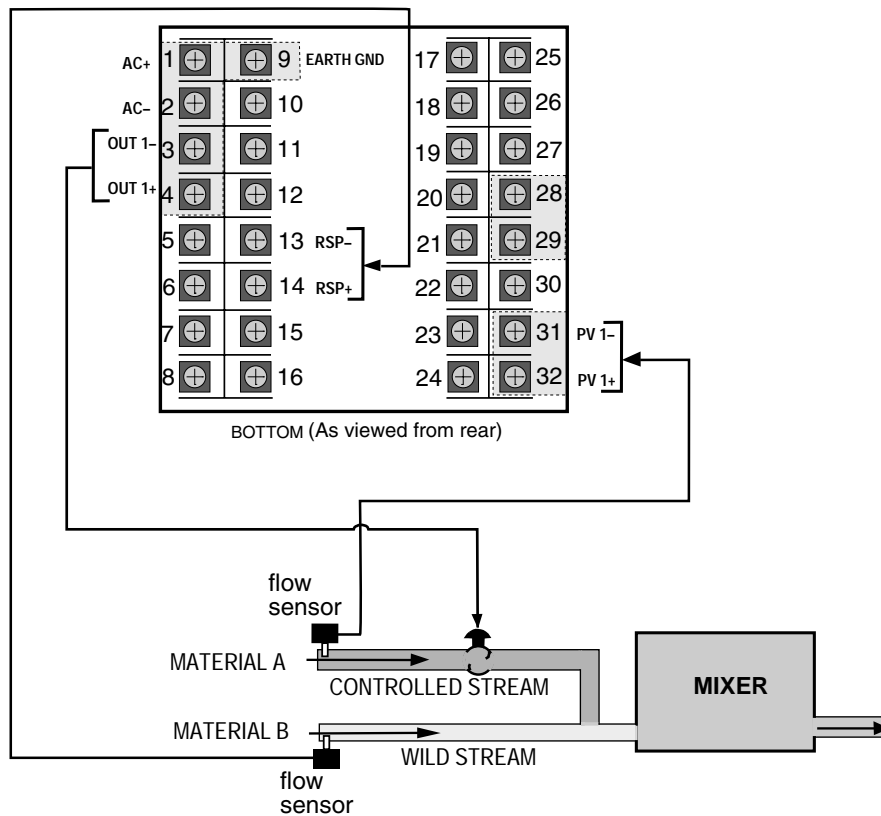

Figure 7.21
Ratio Control in Mixing Application

Hardware Configuration

- Set the process variable jumper and remote setpoint jumper to mA. Make sure that both inputs are set up to accept the corresponding signal from the flow transmitters.
- Wire as in Figure 7.21.

Software Configuration

1. Make sure that the range of both inputs matches the range of the corresponding transmitter:

- a. Go to the **PV INPUT** menu.
 - b. Set the **HI. RANGE** and **LOW RANGE** parameters.
 - c. Go to the **REM. SETPT.** menu.
 - d. Set the **RSP:HI RNG.** and **RSP:LO RNG.** parameters.
2. Adjust the ratio between the two streams:
- a. Go to the **TUNING** menu.
 - b. Set the **RSP RATIO** parameter. The value of this parameter will be multiplied by the remote setpoint signal to yield the effective remote setpoint.

APPENDIX 1 MENU FLOWCHARTS

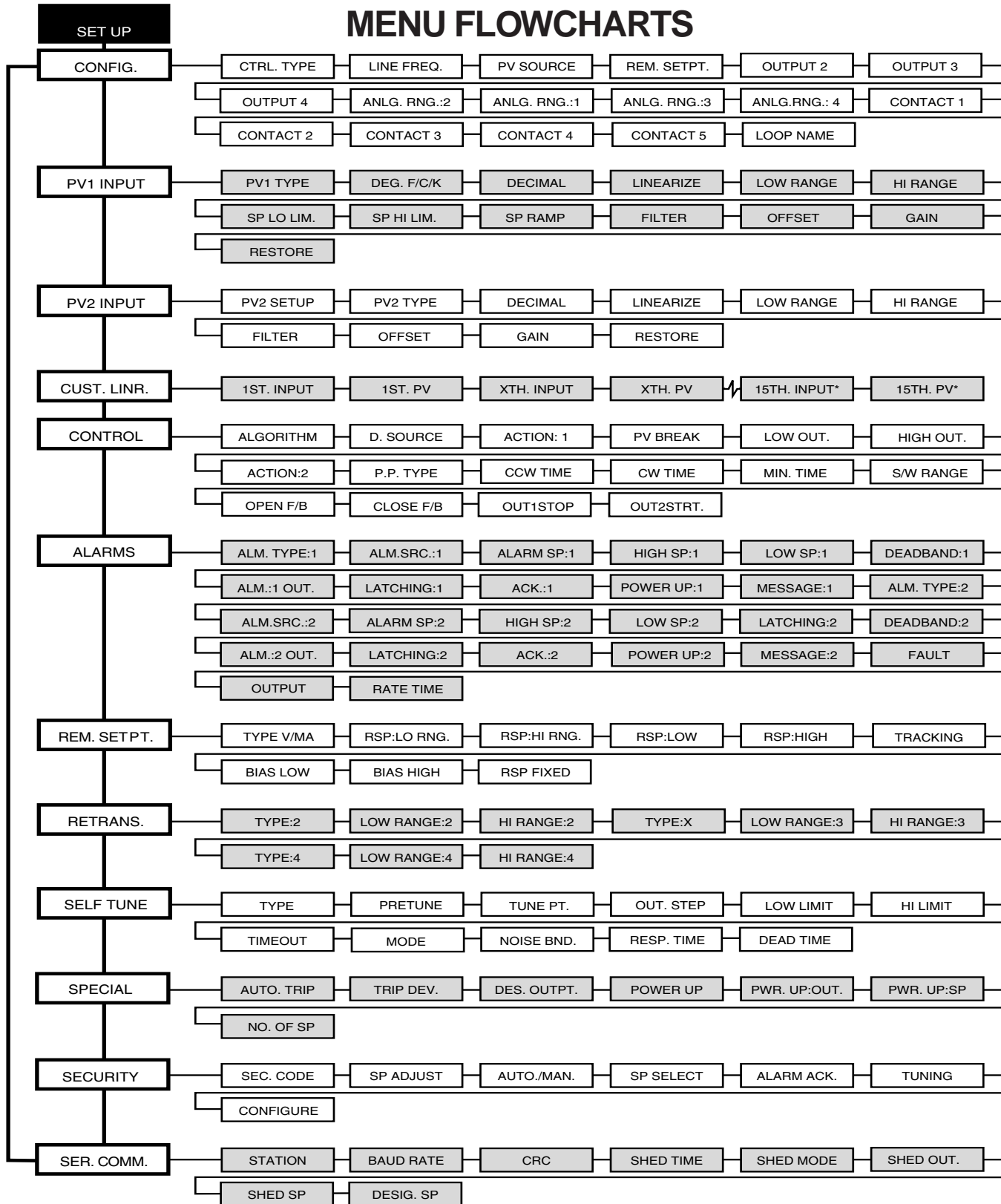

Menu Flowcharts

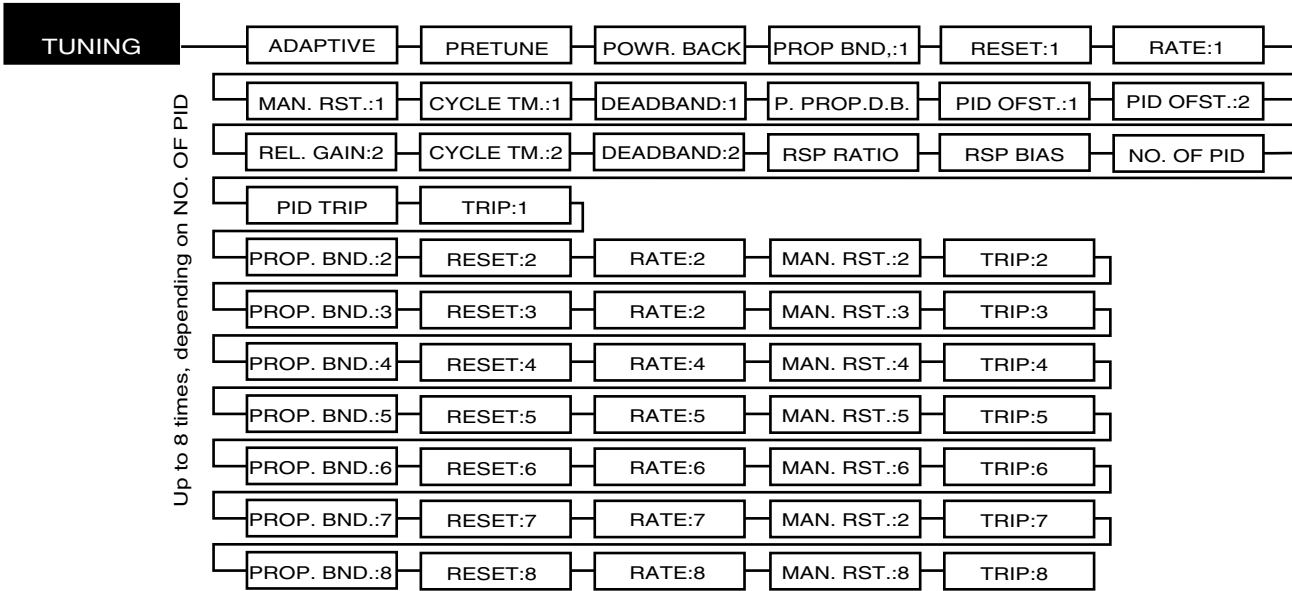

APPENDIX 2 PARTS LIST

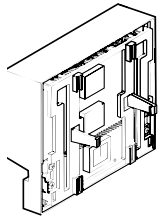

OPERATOR
INTERFACE
ASSEMBLY
shown with bezel
insert in place

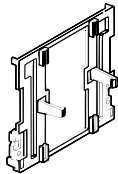

CIRCUIT
BOARD SUPPORT
(BEZEL INSERT)

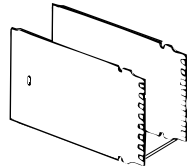

CIRCUIT BOARDS

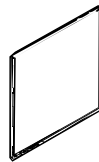

BEZEL
GASKET

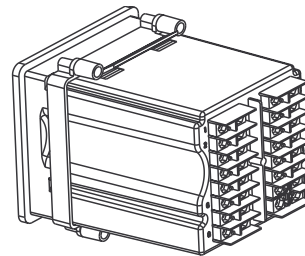

CONTROLLER BODY
shown with mounting
collar in place

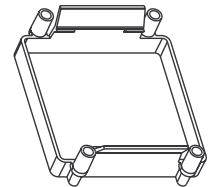

MOUNTING
COLLAR

ITEM	PART #
Output Modules	
Mechanical Relay Module	535 600
Analog (milliamp Module)	535 601
Solid State Relay Module	535 602
DC Logic (SSR Drive) Module	535 603
Loop Power Module	535 604
RS-485 Communications Module	535 705
Repair/Replacement Parts	
Operator Interface Assembly	535 632
Power Supply Circuit Board	535 730
Microcontroller Circuit Board	535 731
Option Circuit Board w/no Options	535 720
Option Circuit Board w/Set of 5 Digital Contacts	535 721
Option Circuit Board w/Slidewire Feedback	535 722
Option Circuit Board w/set of 5 Digital Contacts & Slidewire Feedback	535 723
EPROM without Remote Setpoint Option	535 740
EPROM with Remote Setpoint Option	535 741
Lithium Battery	093 044
Jumper Kit: Set of All Jumper Connectors	535 660
Gasket Kit: 1 Panel Gasket & 1 Bezel Gasket	535 662
Mounting Kit: Mounting Collar & 4 screws	535 761
Bezel Retention Screw Kit	535 663
Module Retention Kit for Outputs 1-3 (Includes Retention Plate)	535 664
Module Retention Kit for Output 4: Set of 5 Tie Wraps	535 665
Circuit Board Support (Bezel Insert)	535 075
Engineering unit labels (1 sheet)	535 106

Parts List

APPENDIX 3 TROUBLESHOOTING

SYMPTOM	PROBLEM	SOLUTION
Display will not light up	Defective power source	Check power source and wiring
	Improper wiring	Correct wiring
	Blown in-line fuse	Check wiring, replace fuse
	Unit not inserted in case properly; or, screws have not been tightened.	Remove unit from case (and remove bezel screws), then reinsert unit and properly tighten screws.
Improper/Lost PV reading • Voltage/current	Input jumper selection improperly set	Move jumper to proper location
	Input range improperly selected in software	Select proper range
	Reverse polarity	Check and correct sensor wiring
	If controller powered, improperly wired	Check and correct wiring
	Loop power module not installed	Install module
	Defective transmitter	Replace transmitter
	Transmitter signal out of range	Select proper range in software
Improper/Lost PV reading • Thermocouple	Defective thermocouple	Replace thermocouple
	Input jumper selection improperly set	Select Proper input
	Wrong TC type selected in software	Select proper thermocouple type in software
	Improper wiring	Wire properly
Improper/Lost PV reading • RTD	Defective RTD	Replace RTD
	Input jumper selection improperly set	Move jumper connector to proper location
	Improper wiring	Wire properly
No control output	Output wiring and module location do not match	Check and correct wiring or module location
	If SSR, SSR Drive of Milliamp output, jumpers J1, J2 and J3 are not set properly	Set jumper connector to proper location
	Software configuration does not match hardware	Reconfigure software to match hardware
	PID values not set properly	Set PID values properly
Can't switch to auto control	Input sensor signal is not connected or valid	See PV LOST message
Erratic display	Resetting action due to electrical noise on powerline	Filter power line.
	PID values not set properly	Retune controller

Troubleshooting

Message	When does it occur?	What to do:
DEFAULTS	Whenever the memory is cleared and all parameters revert to factory default settings. This may be done by purposely clearing the memory or when the unit is powered up for the first time or if the software version is changed.	Entering the Set Up mode and changing a parameter will clear the message. If due to something other than the user purposely clearing the memory, call factory for assistance.
LOST CAL. or ERROR: BAD CAL. DATA	Indicates that the calibration data has been lost. Occurs if all the memory has been erased.	Problem should never happen. Must correct the situation and recalibrate. Call factory for assistance.
PV1 UNDER or PV1 OVER or PV2 UNDER or PV2 OVER or	When the process variable value travels slightly outside the boundaries of the instrument span. Does not apply to thermocouple or RTD inputs.	May not need to do anything. May want to check the transmitter accuracy and check to see if range of transmitter matches the range of the controller.
LOST PV1 or LOST PV2	When the controller senses a lost process variable signal or the input signal travels well beyond the instrument span.	Check wiring and sensor/transmitter.
LOST RSP	When the remote setpoint is in use and the controller senses that the signal has been lost or has traveled well outside the range.	Check wiring and remote setpoint source.
COMM SHED	When the communications is lost for longer than the communications shed time.	Check communications wiring, etc. To clear message, must make an auto/manual change.
ERROR: ROM CHECKSUM	On power up a problem with the EPROM is detected. Controller locks up until fixed.	This is a fatal error and requires an EPROM change. Call factory for assistance.
OUT1 CONF or OUT2 CONF	Upon power up, controller senses that the modules needed for control as determined by software configuration are not present.	Must power down and install correct module combination or must reconfigure the controller to match the current module combination.
LOST F/B	The slidewire feedback is sensed as lost.	Check the slidewire wiring.
LOST CJC	The cold junction is sensed as lost.	Call factory for assistance.
ERROR: BAD EEPROM	During power up an EEPROM failure is detected. Controller locks up until fixed.	This is a fatal error and requires an EPROM change. Call factory for assistance.
NEEDS CAL.	When the controller is powered up with default calibration data (input and output accuracy specifications may not be met).	Enter calibration menu and recalibrate the controller. Call factory for assistance.
ERROR: BAD MODEL NUM.	During power up, a discrepancy was found between the EEPROM's and controller's model numbers. Controller locks up until fixed.	This is a fatal error and requires an EPROM or EEPROM change. Call factory for assistance.
CAL.ERROR SEE.MANUAL	During cold junction calibration, a discrepancy was found between the controller type and the case type.	Install the 535 chassis into the actual case with which it was shipped, then run calibration again. If you experience further problems, call factory for assistance.

APPENDIX 4 CALIBRATION

- To maintain optimum performance, once a year calibrate the analog input, the cold junction and milliamp output (when used). To achieve published accuracy specifications, follow directions carefully and use calibrated instruments of like quality to those suggested.
- If the controller is moved into an alternate case, or the hardware configuration is changed, and the thermocouple input is needed, recalibrate the cold junction for maximum accuracy. Failure to do so may result in small junction temperature (0.6°C/1.1°F).

Access the parts of the calibration menu as shown in *Figure A4.2*.

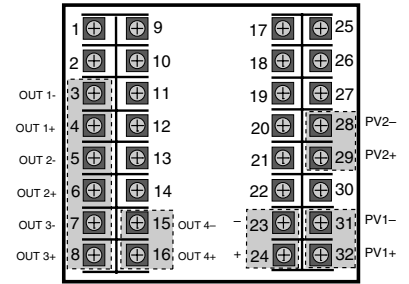

Figure A4.1
535 Rear Terminals for Calibration

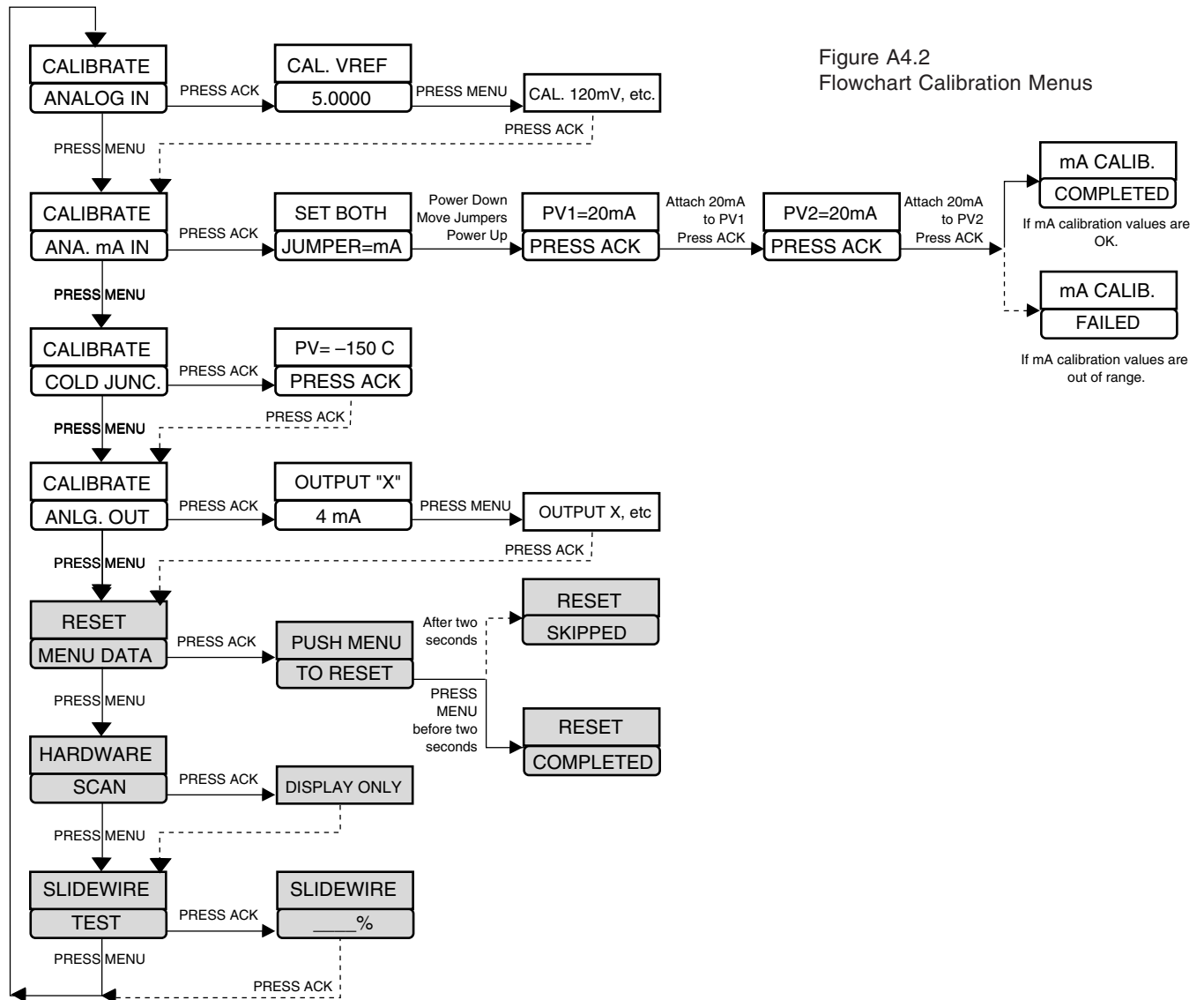
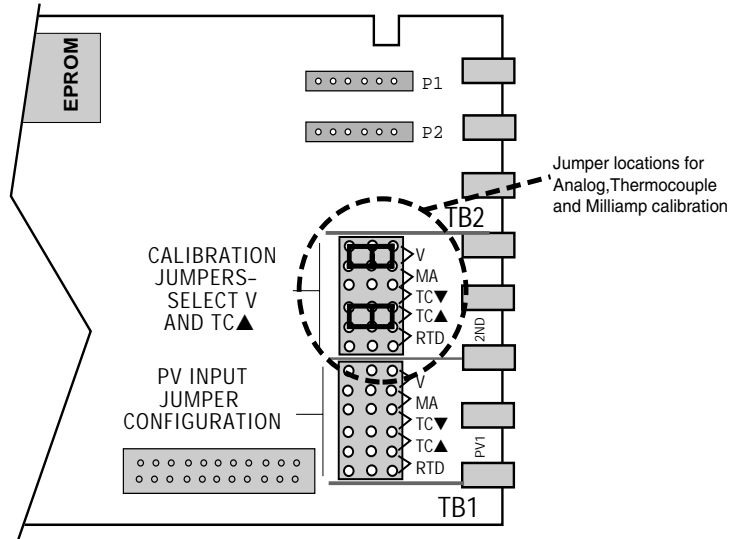

Figure A4.2
Flowchart Calibration Menus

Calibration

Figure A4.3
Jumper Locations on the
Microcontroller Circuit Board



Preparation for all Input Calibrations

Equipment for analog input calibration:

- Precision 5-1/2 or 6-1/2 digit multimeter, e.g., Fluke 8842® or HP3478A® (a 4-1/2 digit meter will sacrifice accuracy)
- Four small pieces of wire
- Test leads with clips
- #2 Phillips screwdriver

Additional equipment for thermocouple input:

- Precision thermocouple calibrator, e.g., Micromite II® by Thermo Electric Instruments
- Special limits grade, Type T thermocouple wire

1. Disconnect power to the instrument.
2. Remove chassis from case.
3. On the Microcontroller Circuit Board, locate jumper locations marked PV1 and 2nd near the edge connector. Reposition both jumper connectors in the 2nd location onto pins for V and TC▲ as shown in *Figure A4.3*.
4. Connect hook up wires between terminals 31 and 32 and the multimeter as shown in *Figure A4.4*.
Set the meter for **DC volts**.
5. Reinsert chassis into the case and apply power.
The 2nd and 3rd display should read CALIBRATE ANALOG IN.
6. Allow the controller to warm up for at least 30 minutes.
7. Press the **ACK** key to get to the first step/parameter.
The 2nd display should show CAL. VREF; the 3rd display should show a value close to 5.0000.
8. The multimeter should read a value in the range 4.9750 - 5.0250.
Use the ▲ and ▼ (and **FAST**) keys on the controller until the display on the controller matches the meter reading.

Figure A4.4
Input Calibration Wiring

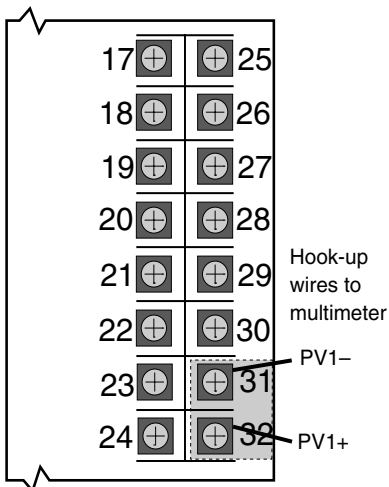

WARNING!

ELECTRIC SHOCK HAZARD!

Terminals 1 and 2 carry live power. DO NOT touch these terminals when power is on.

9. Press **MENU** key.
The 2nd display should show CAL. 120mV. The 3rd display should show a value close to 120.000. Match controller display to multimeter value using ▲ and ▼ keys.
10. Press **MENU** four more times. Each time, match the displays of the controller and the multimeter. Press **ACK** when done.
The 2nd display should show CALIBRATE; the 3rd display should show ANA. mA IN.
11. Turn off power to the unit.
12. For **thermocouple input**, proceed to the Thermocouple Cold Junction Calibration.
13. For **milliamp input**, proceed to Analog Milliamp Input Calibration.
14. For **milliamp output calibration**, let the controller warm up for 10 minutes, then skip to step 5 of Milliamp Output Calibration.
15. If **calibration is complete**, place all the jumpers back in their original positions (as specified in Chapter 3).

THERMOCOUPLE COLD JUNCTION CALIBRATION

1. Connect the two pairs of T/C wire to terminals 28, 29, 31 and 32 as shown in *Figure A4.5*. Make sure the T/C wires are floating (disconnect from the multimeter also), and are not touching each other.
2. Turn on power to the unit and let controller warm up for 30 minutes in the normal horizontal position: while the unit is warming up, the rear face of the controller should be vertical, not horizontal.
3. Press the **MENU** key until the display indicates CALIBRATE COLD JUNC.
4. Press the **ACK** key. The display should show PV = -150 C PRESS ACK.
5. Connect both pairs of T/C wires in parallel—do not daisy chain—to a Type T thermocouple calibrator. (Both pairs must be connected or the calibration will not be accurate.)
6. Set the thermocouple calibrator to an output value of -150° C for a Type T thermocouple and allow the calibrator to stabilize for a few minutes.
7. Press **ACK** to initiate calibration of the cold junction.
8. For **milliamp output calibration**, proceed to Milliamp Output Calibration. Let the controller warm up for 10 minutes, then skip to step 5.
9. If **calibration is complete**, power down, then place all the jumpers in their original positions (as specified in Chapter 3).

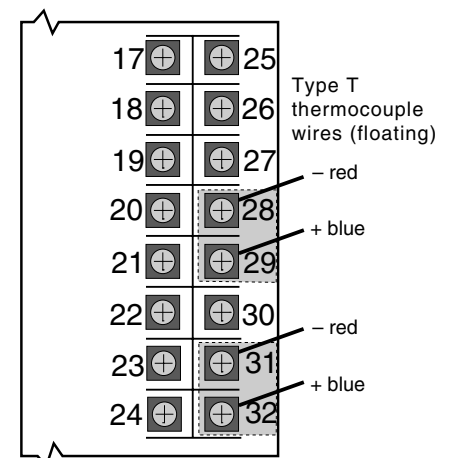

Figure A4.5
Thermocouple/Cold Junction
Calibration Wiring

ANALOG MILLIAMP INPUT CALIBRATION

1. Remove the thermocouple wires (if present) from terminals 28, 29, 31 and 32. Replace them with pieces of wire that will be connected to a 20 milliamp input current (see *Figure A4.6*). Make sure terminal screws are securely tightened, but do not connect the wires yet (leave inputs floating).
2. Turn on power to the unit.
3. Press **MENU** until the display indicates CALIBRATE ANA. mA IN, then press **ACK**.
If the display shows PV1=20mA PRESS ACK, move ahead to step #8.
4. The controller will display SET BOTH JUMPER=mA.
5. Power down the controller and remove chassis from the case.

Calibration

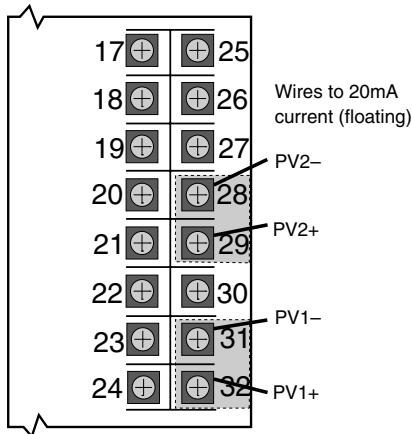

Figure A4.6
Analog mA Input Calibration Wiring

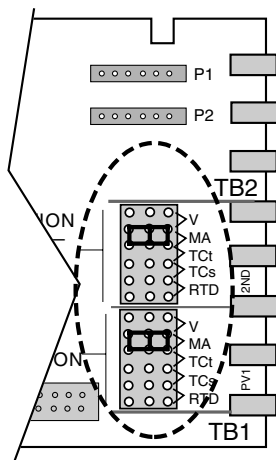

Figure A4.7
Analog mA Input Jumper Positions

6. Remove both input jumper connectors from the pins in the 2nd position. Place one of the jumpers on the PV1 position **mA** pins, and place the other jumper on the 2nd position **mA** pins, as shown in *Figure A4.7*.
7. Reinsert the chassis into the case and apply power. The controller should display PV1=20mA PRESS ACK to indicate it is ready to calibrate the PV1 milliamp input.
8. Connect a precision 20mA input to the PV1 terminals (31 is PV1-, 32 is PV1+). Make sure the terminal connections are fastened tightly and that a 20mA current is flowing through PV1. **Do not** connect the 20mA current to PV2 yet.
9. Let the controller warm up for at least 10 minutes (keep in normal horizontal position). Make sure the current is flowing, then press **ACK** to calibrate the PV1 input.
10. If the controller briefly displays PV2=20mA INPUT, PV1 calibration was successful. Move on to step 12.
11. If the controller briefly displays mA CALIB. FAILED, PV1 calibration was not successful.
Check the 20mA connections, and return to step #3 to recalibrate the PV1 input.
12. Remove the 20mA input from the PV1 terminals, and attach it to the PV2 terminals (see *Figure A4.6*).
Make sure the terminal connections are fastened tightly and that a 20mA current is flowing through PV2.
13. Let the controller warm up for an additional 5 minutes (keep in the normal horizontal position). Make sure the current is flowing, then press **ACK** to calibrate the PV2 input.
14. If the controller briefly displays mA CALIB. COMPLETED, PV2 calibration was successful and the analog milliamp calibration procedure has been completed. If calibration is complete, power down. Place the jumpers into their original positions (see Chapter 4).
15. If the controller briefly displays mA CALIB. FAILED, PV2 calibration was not successful. Check the 20mA connections, and return to step #3 to recalibrate the PV1 and PV2 inputs.

MILLIAMP OUTPUT CALIBRATION

If the controller uses milliamp outputs, it is usually not necessary to calibrate them. If the milliamp outputs are being used for accurate retransmission of data, it is recommended that each output with an analog module be calibrated annually to maintain optimal performance.

Equipment needed:

- Precision 5-1/2 digit multimeter, e.g., Fluke 8842® or HP3478A® (4-1/2 digit meters sacrifice accuracy)
 - Two small pieces of wire for every milliamp output
 - Test leads with banana clips
 - #2 Phillips screwdriver
1. Disconnect power to the instrument.
 2. Remove chassis from case.

- On the Microcontroller Circuit Board locate jumper locations marked PV1 and 2nd near the edge connector. Reposition both jumper connectors in the 2nd location onto pins for V and TC▲, as shown in *Figure A4.3*.
- Reinsert chassis into the case and apply power.
- Allow controller to warm up for at least 30 minutes.
The 2nd and 3rd displays should read CALIBRATE ANALOG. IN. (**CALIBRATE** Menu, **ANALOG. IN** section).

Press **MENU** three times to reach the **CALIBRATE ANLG. OUT** Menu.

- Connect hook up wires to the terminals for the corresponding milliamp output modules.

Output 1 uses terminals 3 and 4.

Output 2 uses terminals 5 and 6

Output 3 uses terminals 7 and 8 (shown in *Figure A4.8*)

Output 4 uses terminals 15 and 16.

Attach the test leads from the multimeter to the wires, and then plug the test leads into the meter. Set the meter for DC milliamp.

- Press **ACK**. The 2nd display will read OUTPUT1, OUTPUT2, OUTPUT3 or OUTPUT4 (depending on the module installation).

- Press **MENU** to scroll to the output to be calibrated (see *Figure A4.9*). The 3rd display should read 4 mA.

The multimeter should read a value close to 4.00.

- Wait one minute. Use ▲ and ▼ (and **FAST**) on the controller to change the meter's display to exactly 4.00 mA.

- Press **MENU**. The 3rd display should read 20 mA.

- Let this setting stabilize for 5 minutes. Use ▲ and ▼ (and **FAST**) on the controller to change the meter's display to exactly 20mA.

- To calibrate another analog output:**

Move the wires and test leads to the new output terminals.

Press **MENU** until the 3rd display shows 4mA for the corresponding output in the 2nd display. Repeat step 9-11.

- To complete calibration, press **ACK** key, disconnect the power and place the jumper connectors back into their original position.

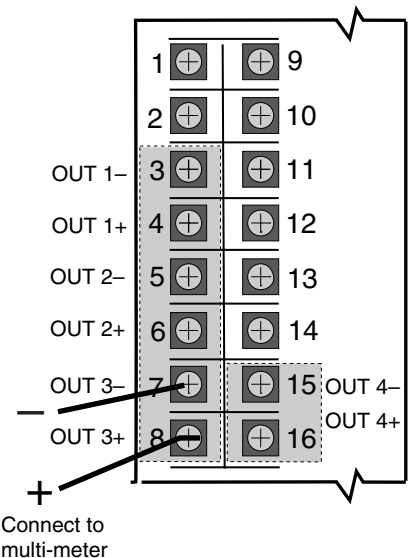

Connect to multi-meter

Figure A4.8
Milliamp Output Calibration Wiring

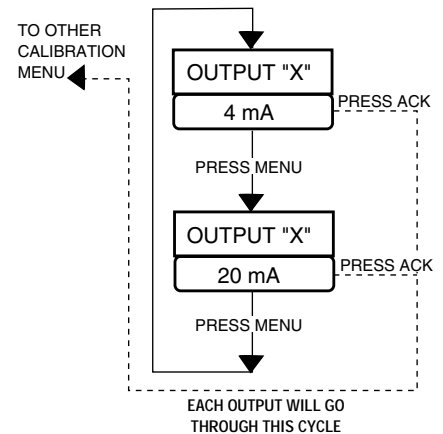

Figure A4.9
Output Module Menu Cycle

RESET MENU DATA

Resets all parameter values back to their factory default values (except for calibration information). Refer to the flowchart in *Figure A4.2*.

- Disconnect power to the instrument.
- Remove chassis from case.
- On the Microcontroller Circuit Board, set jumpers at the 2nd PV location to **V** and **TC▲**.
- Press **MENU** key until the display shows RESET MENU DATA.
- Press the **ACK** key.
- Press **MENU** key within two seconds to reset the menu data.
If successful, RESET COMPLETED will appear in the display.
If failed, RESET SKIPPED will appear instead.
- To try again, press **ACK** key, and then press **MENU** key within two seconds.
- When complete, return jumpers to their original positions.

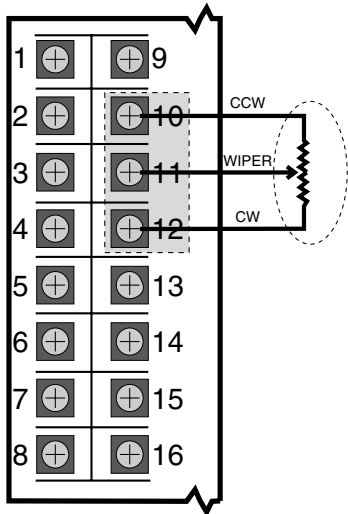

Figure A4.10
Slidewire Test Wiring

HARDWARE SCAN

Use this read-only feature to identify the output hardware and installed options of the controller.

1. Set the jumpers to **V** and **TC▲** (see Figure A4.3).
2. Power up the controller.
3. Press **MENU** until **HARDWARE SCAN** is displayed.
4. Press **ACK** to initiate the hardware display.
5. When complete, return jumpers to their original positions.

SLIDEWIRE TEST

If the slidewire option is installed, use the following to test its function:

1. Press **MENU** to scroll to the **SLIDEWIRE TEST** menu (refer to Figure A4.2)
2. Attach a 100 to 1000 ohms potentiometer to terminals 10, 11 and 12 as shown in Figure A4.10.
3. Moving the potentiometer from one end to the other should display from “0%” to “100%” on the controller.
4. If the error message **OPEN** appears, check the connectors and try again.
5. Press **ACK** to exit.

QUICK CALIBRATION PROCEDURE

This procedure may benefit users that have ISO or other standards requiring periodic calibration verification. It enables verification and modification of the PV input without entering the “Factory Configuration” mode.

1. Power down the 545 controller and place the input jumpers in the desired position (refer to Figure A4.2 and Figure A4.7).
2. Replace the process variable (PV1 or PV2) input signal with a suitable milli-amp calibration device.
3. Apply power and allow controller to warm up for 30 minutes.
4. Place controller in manual mode. Then press **MENU** and **FAST** together to reach the **PV1 INPUT** or **PV2 INPUT** menu.
5. Press **MENU** until the **OFFSET** parameter appears in the 2nd display.
6. Adjust the calibration device to an output signal equal to the 0% range value for the particular input sensor (for example, 4mA for a 4-20 mA input).
7. Verify value indicated in the 1st display is equal to the 0% range value for the particular input sensor. If incorrect use the **▲** and **▼** keys to scroll to the correct value.
8. For linear voltage or mA input: Press **MENU** until the **PV GAIN** parameter appears in the 2nd display.
For thermocouple or RTD input: go to step 9.
9. Adjust the calibration device to an output signal equal to the 100% range value for the particular sensor.
10. Verify that the value shown in the 1st display is equal to 100% of the range value for the particular input sensor. If the value is not correct, use the **▲** and **▼** keys to scroll to the correct value.
11. Repeat steps 4 through 10 to verify all values.
12. Press **DISPLAY** to return to the Operation mode.

APPENDIX 5 SPECIFICATIONS

ACCURACY	TYPICAL	MAXIMUM
LINEAR (Voltage)	± 0.025% of full scale	± 0.100% of full scale
(Current)	± 0.050% of full scale	± 0.150% of full scale
RTD 1.0°	± 0.050% of span	± 0.150% of span
0.1°	± 0.095% of span	± 0.225% of span
THERMOCOUPLE		
J, K, N, E (> 0°C)	± 0.060% of span	± 0.150% of span
J, K, N, E (< 0°C)	± 0.150% of span	± 0.375% of span
T (> 0°C)	± 0.100% of span	± 0.250% of span
T (< 0°C)	± 0.250% of span	± 0.625% of span
R, S (> 500°C)	± 0.150% of span	± 0.375% of span
R, S (< 500°C)	± 0.375% of span	± 0.925% of span
B (> 500°C)	± 0.150% of span	± 0.375% of span
B (< 500°C)	± 0.500% of span	± 1.000% of span
W, W5 & Platinel II	± 0.125% of span	± 0.325% of span

Display accuracy is ± 1 digit. These accuracy specifications are at reference conditions (25°C) and only apply for NIST ranges. Detailed accuracy information is available upon request.

CONTROL ALGORITHM

PID, P with manual reset, PI, PD with manual reset, and On-Off are selectable from the front panel. Duplex outputs each use the same algorithm, except On-Off may be used with PID. The PID algorithm used is non-interacting.

TUNING PARAMETERS

Proportional Band: 0.1 to 999% of input range

Integral: 1 to 9999 seconds/repeat

Derivative: 0 to 600 seconds

Manual Reset/Load Line: 0 to 100% output

Cycle Time: 0.3 to 120 seconds

On-Off Deadband: up to 15% of input range (in eng. units)

Up to eight sets of PID values may be stored in memory and selected automatically, based on setpoint value, process variable value, or the corresponding local setpoint (SP1–SP8).

SELF TUNING OF PID VALUES

POWERTUNE® On-demand “pretune”: This is an open loop algorithm that may be used on its own to calculate PID variables, or it can be used to provide preliminary PID values, as well as process identification information to be used by the adaptive tune.

Three pretune types are available: TYPE 1 for slow thermal processes; TYPE 2 for fast fluid or pressure applications; and TYPE 3 for level control applications.

Adaptive tune: Our exclusive POWERTUNE® adaptive tuning algorithm automatically adjusts the PID values whenever a process upset occurs. Preliminary information may be input manually or automatically calculated by our pretune algorithm.

OVERSHOOT PROTECTION

POWERBACK is Powers' proprietary, user-invoked, setpoint overshoot protection algorithm. When invoked, POWERBACK reduces or eliminates setpoint overshoot at power up or after setpoint changes. POWERBACK monitors the process variable to make predictive adjustments to the control parameters, a feature that helps eliminate overshoot of setpoint.

ISOLATION

Inputs and outputs are grouped into the following blocks:

Block 1: process variable

Block 2: outputs 1, 2, 3 and 4

Block 3: communications, set of five digital inputs

Block 4: remote setpoint

Each block is electrically isolated from the other blocks to withstand a HIPOT potential of 500 Vac for 1 minute or 600 Vac for 1 second, with the exception of blocks 1 and 4, which are not isolated, but is capable to withstand a potential of 50 volts peak for 1 minute between each other. Inputs and outputs are not isolated from other inputs and outputs within the same block.

CONTROLLER ARCHITECTURE

The 535 Controller hardware can be configured as follows:

Inputs: One universal process variable input is standard. Available options include: remote setpoint, slidewire feedback and 5 digital inputs.

Outputs: Four outputs are available. See Ordering Information.

RS-485 Communications: Available as option with any configuration.

PROCESS VARIABLE INPUTS - 2 PROCESS VARIABLES AVAILABLE

Universal input type. Any input type may be selected in the field. Selection of input type (thermocouple, RTD, voltage or current) via jumper. Selection of particular sensor or range is via front panel.

THERMOCOUPLES	RANGE °F	RANGE °C
B	104 to 3301	40 to 1816
E	–454 to 1832	–270 to 1000
J	–346 to 1832	–210 to 1000
K	–418 to 2500	–250 to 1371
N	–328 to 2372	–200 to 1300
R	32 to 3182	0 to 1750
S	32 to 3182	0 to 1750
T	–328 to 752	–200 to 400
W	32 to 4172	0 to 2300
W5	32 to 4172	0 to 2300
Platinel II	–148 to 2550	–100 to 1399

Specifications

RTDs	RANGE °F	RANGE °C
100 Pt. (DIN)	-328 to 1562	-200 to 850
	-328.0 to 545.0	-200.0 to 285.0
100 Pt. (JIS)	-328 to 1202	-200 to 650
	-328.0 to 545.0	-200.0 to 285.0
100 Pt. (SAMA)	-328 to 1202	-200 to 650
	-328.0 to 545.0	-200.0 to 285.0

TRANSMITTER SIGNALS	INPUT RANGE
Milliamps DC	4 to 20
	0 to 20
Voltage DC	1 to 5
	0 to 5
Millivolts DC	0 to 10
	0 to 30
	0 to 60
	0 to 100
	-25 to 25

LINEARIZATION

Thermocouple and RTD inputs are automatically linearized. Transmitter inputs may be linearized with a square root function or user-definable 15-point straight line linearization function.

INPUT IMPEDANCE

Current Input: 250 ohms
Voltage Input: 1 Mohms
Thermocouples: 10 Mohms
RTDs: 10 Mohms

UPDATE RATE

Input is sampled and output updated 10 times per second. Display is updated five times per second.

TRANSMITTER LOOP POWER

Isolated 24 Vdc (nominal) loop power supply is available if a loop power module is installed in an output socket not used for control. Capacity is 25 mA.

INPUT SIGNAL FAILURE PROTECTION

When input is lost, output is commanded to a predetermined output (-5 to 105%). Thermocouple burnout is selectable for upscale or downscale.

INPUT FILTER

Single pole lowpass digital filter with selectable time constant from 0 to 120 seconds.

CALIBRATION

Comes fully calibrated from the factory and continuously calibrates itself for component aging due to temperature and time, except for the reference voltage. Field calibration can be easily performed in the field with a precision multimeter and thermocouple simulator. Process variable offset and gain factors are provided to correct for sensor errors.

OUTPUT MODULES

The controller can have a total of four control outputs, alarm outputs and/or loop power modules installed. There are five types of output modules which can be configured to suit your particular application. The modules may be ordered factory-installed, or they may be installed in the field.

Analog module: Either 0–20 mA or 4–20 mA (front panel selectable) into a load up to 1000. Accuracy $\pm 15\mu\text{A}$ @ 25°C.

Mechanical relay module: SPDT electromechanical relay.

Resistive load rated at 5 amps at 120/240 VAC. Normally open or normally closed selection is made by jumper. Output 4 is rated at 0.5 amps at 24 VAC and is always normally open.

Solid state relay (triac) module: Resistive load rated at 1 amp at 120/240 VAC. Output 4 is rated at 0.5 amps at 24 VAC. These outputs are normally open.

DC logic (SSR drive) module: “ON” voltage is 17 Vdc (nominal). “OFF” voltage is less than 0.5 Vdc. (Current limited to 40mA.)

Loop power supply module: Current is limited to 25 mA @ 24V (nominally loading).

CONTROL OUTPUTS

Up to two output modules may be designated for control. Any combination of output modules, with the exception of the loop power supply module, may be used.

Duplex control is available if output modules are installed in the first and second output sockets.

Position proportioning control with feedback is available if mechanical or solid state relay modules are installed in the first two output sockets, and the slidewire feedback option is installed. Slidewire feedback range is 0 to 1050 ohms.

“**Velocity**” **position proportioning control** is available by installing mechanical or solid state relay modules in the first two output sockets. A special algorithm controls an electric actuator without the slidewire feedback signal.

Staged (split range) outputs are available if analog modules are installed in the first and second output sockets. This algorithm will allow the output range to be split between the two outputs.

RETRANSMISSION OUTPUT

Based on available outputs (any socket not used for control), up to two different variables can be simultaneously programmed for retransmission. Each precise, 16-bit resolution output may be scaled for any range. Variable selection includes: PV, SP, RAMP SP, and OUTPUT.

ALARMS

The 535 controller has two software alarms. High and low alarms may be sourced to the PV, SP, RAMP SP, DEVIATION and OUTPUT. If an alarm is tripped, the alarm message will show, the ACK key will illuminate (if acknowledgeable) and the ALM icon will light. If the alarm is tied to the first available non-control output, the “1” below the ALM icon will light. Similarly, if the alarm is tied to the second non-control output, the “2” below the ALM will light. The availability of outputs determines how many alarms can be tied to relays.

Up to two alarm outputs are available if an associated mechanical, solid state relay or DC logic module is installed in any output socket not used for control.

Global Alarm feature allows one or more of the internal software alarms to be tied to the same single, physical output. The acknowledge key is active for alarms associated with either loop.

DIGITAL INPUTS

A set of five external dry contacts or open collector transistor driven inputs are available. Each can be configured to perform one of the following functions:

- Select remote setpoint
- Select manual control
- Select second local setpoint
- Select a second set of PID values
- Acknowledge alarms
- Simulate ▲ and ▼ keys
- Simulate DISPLAY, FAST and MENU keys
- Select either direct or reverse control action
- Disable adaptive tuning
- Addressable through serial communications only
- Inhibit the reset term
- Lock controller in manual mode
- Select PV1 or PV2

In addition, if the set of five digital inputs is installed, four may be designated to select one of eight local setpoints (and associated PID set, if desired) via a binary coded decimal (BCD) input.

SETPOINT SELECTION

A remote setpoint input is available. Signal is 0–20/4–20 mADC or 0–5/1–5 VDC (jumper selectable). Signal may be ratioed and biased. Eight local setpoints may be stored in memory. Setpoint selection is made via SET PT key or digital contact(s).

FAULT OUTPUT

One of the alarm outputs may be designated to also energize if the input signal is lost.

SERIAL COMMUNICATIONS

Isolated serial communications is available using an RS-485 interface. Baud rates of up to 19,600 are selectable. The protocol supports CRC data checking. If communications is lost, a time-out feature will command the controller to a particular control mode and specific setpoint or output if desired. Outputs 2–4 and digital inputs can act as “host-controlled” I/O independent of the controller’s function. The PV may be sourced via this interface. May be installed in the field.

DIGITAL DISPLAYS

Upper display: five-digit, seven-segment. Used exclusively for displaying the process variable value. Height is 15 mm (0.6 in.).
2nd display: nine-character, 14-segment alphanumeric. Used for displaying setpoint, deviation, output value, slidewire position (actual valve position) and configuration information. Height is 6mm (0.25 in.).
3rd display: nine-character, 14-segment alphanumeric. Used for indicating which loop is displayed and for displaying alarm messages and configuration information. Height is 6mm (0.25 in.).
 All displays are vacuum fluorescent. Color is blue-green.

STATUS INDICATORS

There are two types of indicators: icons and illuminated keys.
 ALM 1 and ALM 2 icons: alarm 1 and alarm 2 status.
 OUT 1 and OUT 2 icons: control output 1 and control output 2 status.
 MAN key illuminated: controller is in manual control mode.
 ACK key illuminated: alarm may be acknowledged.
 SET PT key illuminated: setpoint other than primary local setpoint is active.
 MENU key illuminated: controller is in configuration mode.

DIMENSIONS

Meets 1/4 DIN designation as specified in DIN standard number 43 700.
 See diagram for details.

MOUNTING

Panel-mounted.

WIRING CONNECTIONS

29 screw terminals in the rear of the instrument.

POWER CONSUMPTION

15 VA at 120 VAC, 60 Hz (typical).

WEIGHT

Approximately 1 kg (2.2 lbs.).

AMBIENT TEMPERATURE

Operative Limits: 0 to 50°C (32 to 122°F).
 Storage Limits: –40 to 70°C (–40 to 158°F).

RELATIVE HUMIDITY

10 to 90%, non-condensing.

VOLTAGE AND FREQUENCY

Universal power supply: 90 to 250 VAC, 48 to 62 Hz.

NOISE IMMUNITY

Common mode rejection (process input): >120 dB.
 Normal mode rejection (process input): >80 dB.
 AC line is double filtered and transient protected. Snubbers are provided for each relay output.

CONSTRUCTION

Case: extruded, non-perforated black anodized aluminum with ABS plastic sleeve.
 Bezel: black plastic ABS.
 Chassis assembly: plug-in type.
 Keys: silicone rubber with diffusion printed graphics.
 NEMA rating: front panel conforms to NEMA 4X when instrument is properly installed.

AGENCY APPROVALS

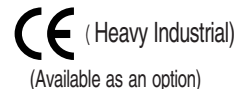

Memory Retention

Lithium battery maintains all programming for approximately ten years.

Security

There are two levels of access: restricted and full. A configurable code is used to enter the full access level. Functions not available in the restricted level are configurable.

(Continued on following page)

APPENDIX 6

GLOSSARY

adaptive control: Control in which automatic means are used to change the type or influence (or both) of control parameters in such a way as to improve the performance of the control system.

adaptive tune: A component of the 535 self tune function which continuously monitors the process and natural disturbances and makes adjustments in the tuning parameters to compensate for or improve the performance of the control system.

alarm: A condition, generated by a controller, indicating that the process has exceeded or fallen below the set or limit point.

alarm, band: A type of alarm set up where a band is created around the control setpoint.

alarm, deviation: An alarm similar to a band alarm except it only creates a band on one side of the alarm setpoint.

alarm, fault: An indication that becomes active upon loss of process variable. Fault alarm operates in addition to other alarm assignments.

alarm, global: The single physical output to which one or more internal software alarms are tied.

alarm, high process variable: A type of alarm that is set up to occur when the process variable goes above the alarm setpoint.

alarm, low process variable: A type of alarm that is set up to occur when the process variable goes below the alarm setpoint.

alarm, manual: A type of alarm set up to occur when the controller is put into manual mode of operation.

alarm, power up: A type of alarm that determines alarm condition on power up of the controller.

alarm, rate-of-change: A type of alarm set up to occur when there is an excessive change in the process variable (PV) value.

baud rate: Any of the standard transmission rates for sending or receiving binary coded data.

bezel: The flat portion surrounding the face of the controller, which holds the keys and display.

bump: A sudden increase in the output power initiated by the controller in order to determine the system response during a self tune procedure.

binary coded decimal (BCD): A notation in which the individual decimal digits are represented by a group of binary bits, e.g., in the 8-4-2-1 coded decimal notation each decimal digit is represented by four binary bits.

calibration: The act of adjustment or verification of the controller unit by comparison of the unit's reading and standards of known accuracy and stability.

cascade control: Control in which the output of one controller is the setpoint for another controller.

closed loop: Control system that has a sensing device for process variable feedback.

cold junction: Point of connection between thermocouple metals and the electronic instrument.

configuration: Also called "set up," selection of hardware devices and software routines that function together.

cold junction compensation: Electronic means used to compensate for the effect of temperature at the cold junction.

contact: In hardware, a set of conductors that can be brought into contact by electromechanical action and thereby produce switching. In software, a symbolic set of points whose open or closed condition depends on the logic status assigned to them by internal or external conditions.

control action: The slope of the output of the instrument in reference to the input, e.g., direct output increases on rise of input. Typical cooling response or reverse output decreases on rise of input (typical heating response).

control action, derivative (rate) (D): The part of the control algorithm that reacts to rate of change of the process variable.

control action, integral (reset) (I): The part of the control algorithm that reacts to offset between setpoint and process variable.

control action, proportional (P): Control action in which there is a continuous linear relation between the output and the input.

control action, proportional plus derivative (PD): A control algorithm that provides proportional control with the addition of derivative action to compensate for rapid changes in process variable.

control action, proportional plus integral (PI): A control algorithm that provides proportional control with the addition of integral action to compensate for offsets between setpoint and process variable.

control action, proportional plus integral plus derivative (PID): A control algorithm that provides proportional control with both integral and derivative action.

control, adaptive: (see adaptive control)

control algorithm: A mathematical representation of the control action to be performed.

control, cascade: (see cascade control)

control output: The end product which is at some desired value that is the result of having been processed or manipulated.

control mode, automatic: A user selected method of operation where the controller determines the control output.

control mode, manual: A user selected method of operation where the operator determines the control output.

control parameters: User defined values that specify how the process is to be controlled.

controlled variable: A process variable which is to be controlled at some desired value by means of manipulating another process variable.

CRC (cyclic redundancy check): An error checking technique in which a checking number is generated by taking the remainder after dividing all the bits in a block

(in serial form) by a predetermined binary number.

cycle time: The time necessary to complete a full ON-through-OFF period in a time proportioning control system.

damping: The decrease in amplitude of an oscillation due to the dissipation of energy.

damped, 1/4 amplitude: The loss of one-quarter of the amount of amplitude with every oscillation.

dead band: A temperature band between heating and cooling functions; the range through which an input can be varied without initiating observable change in output.

dead time: The interval of time between initiation of an input change or stimulus and the start of the resulting observable response.

default settings: Parameters selections that have been made at the factory.

derivative: Anticipatory action that senses the rate of change of temperature, and compensates to minimize overshoot and undershoot. Also "rate."

derivative action: (See control action, derivative)

deviation: The difference between the value of the controlled variable and the value at which it is being controlled.

digital input: Used in this manual to indicate the status of a dry contact; also called "gate".

DIN: Deutsche Industrial Norms, a German agency that sets standard for engineering units and dimensions.

display, 1st: The top, largest display of controller face that is used to display the process variable value.

display, 2nd: The middle display of the controller face used to indicate: in **OPERATION** Mode - the setpoint, deviation or output; in **TUNING** or **SET UP** Mode - the parameter or parameter menu.

display, 3rd: The bottom display of the controller face that is used to indicate: in **OPERATION** Mode - the setpoint, deviation or output; in **TUNING** or **SET UP** Mode - the parameter or parameter menu.

disturbance: An undesired change that takes place in a process that tends to affect adversely the value of a controlled variable.

duty cycle: Percentage of "load ON time" relative to total cycle time.

earth ground: A terminal used on the 535 to ensure, by means of a special connection, the grounding (earthing) of part of the controller.

engineering unit: Terms of data measurement such as degrees Celsius, pounds, grams, etc.

feedback: Process signal used in control as a measure of response to control action; the part of a closed-loop system which automatically brings back information about the condition under control.

FM: Factory Mutual Research Corporation; an organization which sets safety standards.

gain: The ratio of the change in output to the change in input which caused it.

heat/cool control: Control method where the temperature of the end product is maintained by controlling two final elements using two of the 535 outputs.

hysteresis: In ON/OFF control, the temperature change necessary to change the output from full ON to full OFF.

hunting: Oscillation or fluctuation of process temperature between setpoint and process variable.

icons: Indicators on the face of the controller.

input: Process variable information being supplied to the instrument.

integral: Control action that automatically eliminates offset, or “droop”, between setpoint and actual process temperature. Also “reset.”

internal voltage reference: A precision voltage source within the 535 controller, used to establish internal calibration.

isolation: Electrical separation of sensor from high voltage circuitry. Allows for application of grounded or ungrounded sensing element.

offset: Adjustment to actual input temperature and to the temperature values the controller uses for display and control.

JIS: Japanese Industrial Standards. Also Japanese Industrial Standards Committee (JISC). Establishes standards on equipment and components.

jumper: A wire that connects or bypasses a portion of a circuit on the printed circuit board.

jumper connectors: The connecting device that straddles a jumper to connect or bypass a portion of a circuit on a printed circuit board.

linearization: A function the 535 uses to automatically linearize a non-linear signal, either from thermocouple or RTD temperature sensors, through the use of look up tables. The relationship that exists between two variables when the ratio of the value of one variable to the corresponding value of the other is constant over an entire range of possibilities.

linearization, custom: User-definable linearization.

linearization, square root: A function the 535 uses to linearize a non-linear signal corresponding to the flow being measured by flow transmitters.

load line out: A start up output value which is to bring initial output closer to actual steady state output.

loop power: An internal 24-volt current limited power supply used to power 2 or 4 wire transmitter on the input of the controller.

load: The demand for input to a process.

low pass input filter: A method to block fast acting signals (typically noise), while allowing slow acting signals (actual process variable) to pass.

manipulated variable: A quantity or condition which is varied so as to change the value of the controlled variable. (see also control output)

mechanical relay: (see relay)

menu: (see menu block)

menu block: Groups of parameters arranged in the software.

microcontroller: A large scale integrated circuit that has all the functions of a computer, including memory and input/output systems.

NEMA 4X: A National Electrical Manufacturers Association standard for specifying a product's resistance to water and corrosion.

normally open: A switched output (i.e., relay, etc.) whose unpowered state has no connection.

normally closed: A switched output (i.e., relay) whose unpowered state provides connection.

noise: An unwanted component of a signal or variable.

noise band: A measurement of the amount of random process “noise” affecting the measurement of the process variable.

offset: The difference in temperature between the setpoint and the actual process temperature.

ON/OFF control: Control of temperature about a setpoint by turning the output full ON below setpoint and full OFF above setpoint in the heat mode.

open loop: Control system with no sensory feedback.

optimization: The act of controlling a process at its maximum possible level of performance, usually as expressed in economic terms.

output modules: Plug in devices that provide power handling to enable process control. These

modules are either binary (on/off) such as a relay, or analog (continuously variable) for current loop control.

output: Action in response to difference between setpoint and process variable.

overshoot: Condition where temperature exceeds setpoint due to initial power up or process changes.

P control: Proportioning control.

parameter(s): A user-defined variable that specifies how a particular function in the 535 will operate.

PD control: Proportioning control with rate action.

PI control: Proportioning control with auto-reset.

PID control: Proportioning control with auto-reset and rate.

position proportioning: A type of control output that utilizes two relays to control an electric motorized actuator.

POWERBACK®: Powers proprietary algorithm which monitors the PV to make predictive judgements to control parameters in order to reduce or eliminate overshoot at powerup or after setpoint changes.

POWERTUNE®: The Powers exclusive special self-tuning function. Consists of an on-demand pretune that calculates PID values or provide preliminary PID values and process information for the second tuning function. Second tuning function is an adaptive tuning algorithm that automatically adjusts PID values whenever a process upset or setpoint change occurs.

pretune algorithm: A method by which the 535 controller initiates an output value change, monitors the manner of the corresponding process variable change, and then determines the appropriate PID control parameters.

primary loop: The outer loop in a cascade system.

process variable: In the treatment of material, any characteristic or measurable attribute whose value changes with changes in prevailing conditions. Common variables are level, pressure and temperature.

proportional band: The change in input required to produce a full range change in output due to proportional control action.

ramping: (see setpoint, ramping)

rate: Anticipatory action that senses the rate of change of temperature and compensates to minimize overshoot. Also “derivative.”

rate action: The derivative function of a controller.

rate time: The time interval over which the system temperature is sampled for the derivative function.

regulate: The act of maintaining a controlled variable at or near its setpoint in the face of load disturbances.

relay (mechanical): An electromechanical device that completes or interrupts a circuit by physically moving electrical contacts into contact with each other.

relay (solid state): A solid state switching device which completes or interrupts a circuit electrically with no moving parts.

reset: Control action that automatically eliminates offset, or “droop,” between setpoint and actual process temperature. Also “integral.”

reset term: (see reset)

RTD: Resistance Temperature Detector. Resistive sensing device displaying resistance versus temperature characteristics. Displays positive temperature coefficient.

relative gain: An open-loop gain determined with all other manipulated variables constant, divided by the same gain determined with all other controlled variables constant.

retransmission: a feature on the 535 which allows the transmission of a milliamp signal corresponding to the process variable, target setpoint or actual setpoint to another device, typically a chart recorder.

sample interval: The time interval between measurements or observations of a variable.

secondary loop: The inner loop of a cascade system.

self tune: A method of automatically calculating and inserting optimum PID parameters by testing system response and timing.

serial communications: The sending or receiving of binary coded data to a supervisory device such as a personal computer or programmable logic controller.

setpoint: An input variable which sets the desired value of a controlled variable.

setpoint, actual: The desired value of a controlled variable that the controller is currently acting upon.

setpoint, deviation from: The difference of the number of units between the current process variable and the setpoint.

setpoint, ramping: A setpoint which is determined by the ramp function of the controller where over time the controller variable reaches a desired value.

setpoint, target: The end point of the ramp function.

set up: Also called configuration, selection of hardware devices and software routines that function together.

sheds: In serial communications, when the signal is lost.

slidewire position proportioning: An output algorithm that utilizes a slidewire feedback signal to determine the actual position of the actuator being controller.

solid state relay: (see relay, solid state)

SSR drive: A D.C. on/off signal output for controlling a solid state relay.

staged outputs: The set up of two analog outputs, where one analog output varies its signal over a portion of the PID output range, and the second analog output then varies its signal over the remainder of the PID output range.

static discharge: Undesirable current resulting from the discharge of electrostatic energy.

station address: The unique identifier assigned to a device for communications.

thermocouple: Temperature sensing device that is constructed of two dissimilar metals wherein a measurable, predictable voltage is generated corresponding to temperature.

thermocouple break protection: Fail-safe operation that assures desired output upon an open thermocouple condition.

thermocouple upscale burnout (▲): Jumper position that determines whether, when a thermocouple fails, its output is replaced by a millivoltage which will match the thermocouple's maximum value. The jumper connector should be placed in the TC ▲ position.

thermocouple downscale burnout (▼): Jumper position that determines whether, when a thermocouple fails, its output is replaced by a millivoltage which will match the thermocouple's minimum value. The jumper connector should be placed in the TC ▼ position.

three mode control: (See control action PID)

time proportioning control: A control algorithm that expresses output power (0–100%) as a function of percent ON versus percent OFF within a preset cycle time.

time proportioning output: A controller output assigned by software to facilitate time proportional control (typically a relay, SSR, or SSR Drive output).

tracking: A function that defines whether the local setpoint will track the remote setpoint. When the controller is transferred to a local

setpoint, that local setpoint value will match the remote process value when the transfer occurs.

transmitter (2-wire): A device used to transmit data via a two wire current loop. A two-wire transmitter is loop powered.

transmitter (4-wire): A device used to transmit data via a current loop or a DC voltage. A 4-wire transmitter uses 2 wires for data and 2 wires for power.

triac: Solid state switching device used to switch alternating current signals on and off. Triac circuits are sometimes referred to as solid state relays (SSR).

trip point: Value which determines when that set of PID values becomes active.

velocity position proportioning: This is a control technique where valve position is determined by calculating the amount of time it takes to open/close a valve by moving the valve for a portion of that time.

windup: Saturation of the integral mode of a controller developing during times when control cannot be achieved, which causes the controlled variable to overshoot its setpoint when the obstacle to control is removed.

wild stream: In mixing applications that require materials to be mixed to a desired ratio, this is the one part of the material that is uncontrolled.

APPENDIX 7

ISOLATION BLOCK DIAGRAM

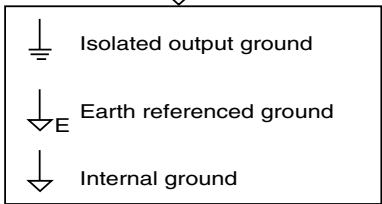
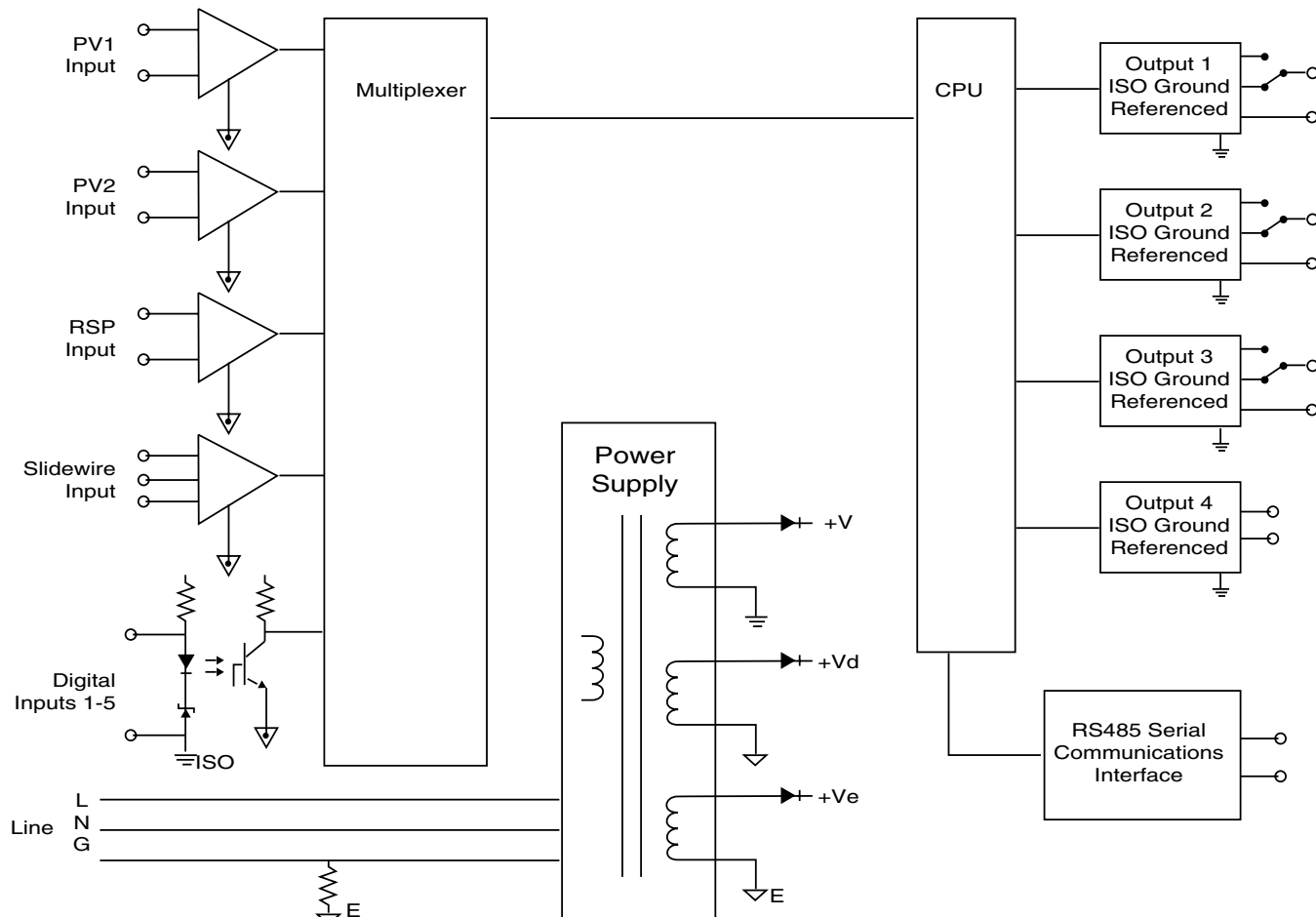

1. Each of the three ground circuits are isolated from each other to withstand a potential of 500 volts for 1 minute, or 600 volts for 1 second.
2. RSP, Slidewire and the PV inputs are not isolated but is capable to withstand 50 volts peak between each other for 1 minute.
3. Milliamp, Loop Power and SSR Drive modules in output positions 1, 2, 3 and 4 are not isolated from each other.

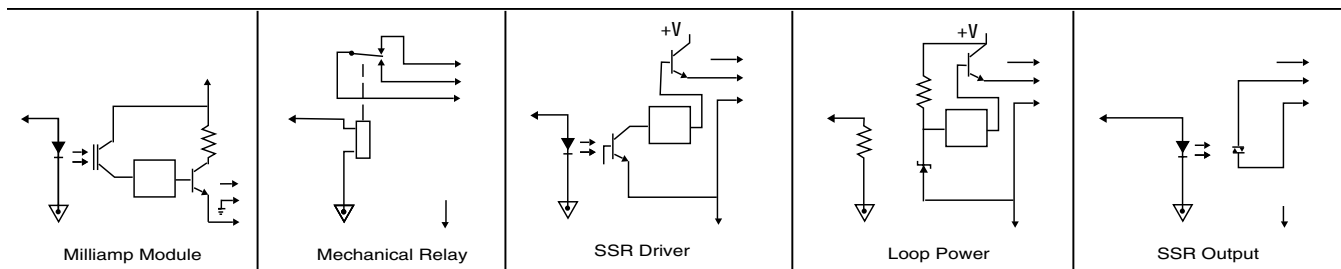

RETURN PROCEDURES

To return equipment to Moore Industries for repair, follow these four steps:

1. Call Moore Industries and request a Returned Material Authorization (RMA) number.

Warranty Repair –

If you are unsure if your unit is still under warranty, we can use the unit's serial number to verify the warranty status for you over the phone. Be sure to include the RMA number on all documentation.

Non-Warranty Repair –

If your unit is out of warranty, be prepared to give us a Purchase Order number when you call. In most cases, we will be able to quote you the repair costs at that time. The repair price you are quoted will be a "Not To Exceed" price, which means that the actual repair costs may be less than the quote. Be sure to include the RMA number on all documentation.

2. Provide us with the following documentation:
 - a) A note listing the symptoms that indicate the unit needs repair
 - b) Complete shipping information for return of the equipment after repair
 - c) The name and phone number of the person to contact if questions arise at the factory
3. Use sufficient packing material and carefully pack the equipment in a sturdy shipping container.
4. Ship the equipment to the Moore Industries location nearest you.

The returned equipment will be inspected and tested at the factory. A Moore Industries representative will contact the person designated on your documentation if more information is needed. The repaired equipment, or its replacement, will be returned to you in accordance with the shipping instructions furnished in your documentation.

WARRANTY DISCLAIMER

THE COMPANY MAKES NO EXPRESS, IMPLIED OR STATUTORY WARRANTIES (INCLUDING ANY WARRANTY OF MERCHANTABILITY OR OF FITNESS FOR A PARTICULAR PURPOSE) WITH RESPECT TO ANY GOODS OR SERVICES SOLD BY THE COMPANY. THE COMPANY DISCLAIMS ALL WARRANTIES ARISING FROM ANY COURSE OF DEALING OR TRADE USAGE, AND ANY BUYER OF GOODS OR SERVICES FROM THE COMPANY ACKNOWLEDGES THAT THERE ARE NO WARRANTIES IMPLIED BY CUSTOM OR USAGE IN THE TRADE OF THE BUYER AND OF THE COMPANY, AND THAT ANY PRIOR DEALINGS OF THE BUYER WITH THE COMPANY DO NOT IMPLY THAT THE COMPANY WARRANTS THE GOODS OR SERVICES IN ANY WAY.

ANY BUYER OF GOODS OR SERVICES FROM THE COMPANY AGREES WITH THE COMPANY THAT THE SOLE AND EXCLUSIVE REMEDIES FOR BREACH OF ANY WARRANTY CONCERNING THE GOODS OR SERVICES SHALL BE FOR THE COMPANY, AT ITS OPTION, TO REPAIR OR REPLACE THE GOODS OR SERVICES OR REFUND THE PURCHASE PRICE. THE COMPANY SHALL IN NO EVENT BE LIABLE FOR ANY CONSEQUENTIAL OR INCIDENTAL DAMAGES EVEN IF THE COMPANY FAILS IN ANY ATTEMPT TO REMEDY DEFECTS IN THE GOODS OR SERVICES. BUT IN SUCH CASE THE BUYER SHALL BE ENTITLED TO NO MORE THAN A REFUND OF ALL MONIES PAID TO THE COMPANY BY THE BUYER FOR PURCHASE OF THE GOODS OR SERVICES.

ANY CAUSE OF ACTION FOR BREACH OF ANY WARRANTY BY THE COMPANY SHALL BE BARRED UNLESS THE COMPANY RECEIVES FROM THE BUYER A WRITTEN NOTICE OF THE ALLEGED DEFECT OR BREACH WITHIN TEN DAYS FROM THE EARLIEST DATE ON WHICH THE BUYER COULD REASONABLY HAVE DISCOVERED THE ALLEGED DEFECT OR BREACH, AND NO ACTION FOR THE BREACH OF ANY WARRANTY SHALL BE COMMENCED BY THE BUYER ANY LATER THAN TWELVE MONTHS FROM THE EARLIEST DATE ON WHICH THE BUYER COULD REASONABLY HAVE DISCOVERED THE ALLEGED DEFECT OR BREACH.

RETURN POLICY

For a period of thirty-six (36) months from the date of shipment, and under normal conditions of use and service, Moore Industries ("The Company") will at its option replace, repair or refund the purchase price for any of its manufactured products found, upon return to the Company (transportation charges prepaid and otherwise in accordance with the return procedures established by The Company), to be defective in material or workmanship. This policy extends to the original Buyer only and not to Buyer's customers or the users of Buyer's products, unless Buyer is an engineering contractor in which case the policy shall extend to Buyer's immediate customer only. This policy shall not apply if the product has been subject to alteration, misuse, accident, neglect or improper application, installation, or operation. THE COMPANY SHALL IN NO EVENT BE LIABLE FOR ANY INCIDENTAL OR CONSEQUENTIAL DAMAGES.



The Interface Solution Experts • www.miinet.com

United States • info@miinet.com
Tel: (818) 894-7111 • FAX: (818) 891-2816
Australia • sales@mooreind.com.au
Tel: (02) 8536-7200 • FAX: (02) 9525-7296

Belgium • info@mooreind.be
Tel: 03/448.10.18 • FAX: 03/440.17.97
The Netherlands • sales@mooreind.nl
Tel: (0)344-617971 • FAX: (0)344-615920

China • sales@mooreind.sh.cn
Tel: 86-21-62481120 • FAX: 86-21-62490635
United Kingdom • sales@mooreind.com
Tel: 01293 514488 • FAX: 01293 387752

500 SERIES

Process Controllers

Form M500 V7

5 0 0

Hardware Installation and Modification Manual

***for Electronic Products
Series 531, 532,
535, 545, 555
Model 2***



Installation

INTRODUCTION

This technical brochure provides hardware installation and modification instructions for our controllers: **Series 531, 532, 535, 545, and 555. Use these instructions with the following kits:**

Display Assembly Kits

531-632	531 Display Assembly Kit
532-632	532 Display Assembly Kit
535-632	535 Display Assembly Kit
545-634	545 Display Assembly Kit
555-632	555 Display Assembly Kit

Output and Communications Module Kits

532-600	531, 532 Analog Module Kit
535-600*	Mechanical Relay Module Kit
535-601*	Milliamp Module Kit
535-602*	SSR Module Kit
535-603*	SSR Drive Module Kit
535-604*	Loop Power Module Kit
535-705*	RS-485 Communications Module Kit

Power Supply Kit

535-730*	90 to 250VAC Power Supply Kit
535-732	24VAC/VDC Power Supply Kit

Mounting Kit

535-761*	Mounting Kit
----------	--------------

Miscellaneous Kits

532-100	531, 532 Bypass Board Kit
535-188*	Rear Terminal Upgrade Kit
535-660	531, 532, 535, 545, 555 Jumper Kit
535-662*	Gasket Kit (1 Panel Gasket, 1 Bezel Gasket)
535-763*	Bezel Retention Screw Kit
535-664*	Module Retention Kit (Retention Plate and Tie Wrap)
535-665*	Module Retention Tie Wrap Kit
093-128*	Lithium Battery

EPROM Kits

531-740	531 EPROM Kit
532-740	532 EPROM Kit
535-741	535 EPROM Kit (RSP)
535-775	535 Profiler EPROM Kit (No RSP)
535-776	535 Profiler EPROM Kit (RSP)
535-740	535 EPROM Kit (No RSP)
545-740	545 EPROM Kit (No RSP)
545-741	545 EPROM Kit (RSP)
555-740	555 EPROM Kit

Microcontroller (MCU) Board Kits

535-731	MCU Board Kit
545-733	MCU Board Kit with CE Option

Option Board Kits

535-720	531, 532, 535, 545 Option Board Kit (No Options)
535-721	531, 532, 535, 545 Option Board Kit (Digital Inputs)
535-722	535, 545 Option Board Kit (Slidewire Feedback)
535-723	535, 545 Option Board Kit (Digital Inputs and Slidewire Feedback)
545-724	531, 532, 535, 545, 555 Option Board Kit (RSP)
545-725	531, 532, 535, 545, 555 Option Board Kit (Digital Inputs and RSP)
545-726	535, 545, 555 Option Board Kit (Slidewire Feedback and RSP)
545-727	535, 545, 555 Option Board Kit (Digital Inputs, Slidewire Feedback, and RSP)

* **Universal Kit (can be used with all 500 Series Controllers)**

HOW TO USE THIS MANUAL:

- CAUTION: Static discharge will cause damage to equipment. Always ground yourself with a wrist grounding strap when handling electronics to prevent static discharge.**
- Before removing or inserting any hardware on the controller, **copy down all configuration parameters**. Also, **replacing the battery, EPROM or MCU Board will erase parameter settings** and they will need to be reset.
- For all hardware adjustments, **perform steps 1, 2 and 3**.
- Follow the guide and complete any additional steps as required by your particular application.
- Complete** your hardware adjustments with **steps 15, 16, 17, 18, 19 & 20**.

EQUIPMENT

To make any hardware changes to the units, you will need the following equipment:

- Wrist grounding strap
- Small flat blade screwdriver
- I.C. Extractor (if changing the EPROM)
- Phillips screwdriver (#2)
- Wire cutters

INSTRUCTIONS

To Disassemble the Unit

For any hardware modifications, disassemble the unit.

1. With power off, loosen four captive front screws with a Phillips screwdriver. Remove the four screws.

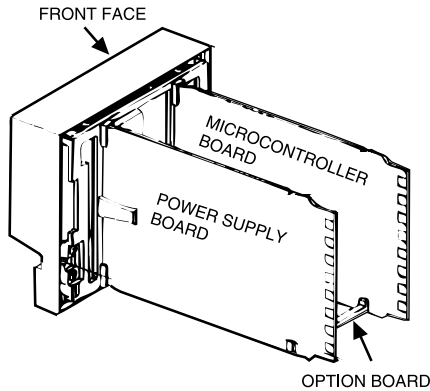

Figure 1
Location of Printed Circuit Boards for Hardware Configuration

2. Slide the chassis out of the case by pulling on front face plate assembly at the bezel (see **Figure 1**).

3. Locate the retention clips holding the front face assembly to the rest of the chassis. Pry apart these retention clips gently with a screwdriver to separate the printed circuit board group from the front face assembly (Photo 3). Take care not to break the clips or scratch the circuit board.

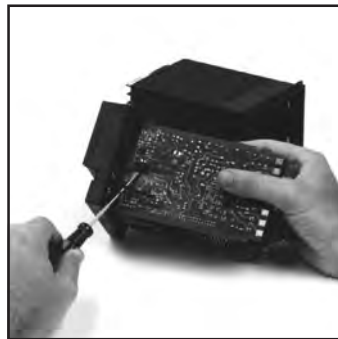

Photo 3. Pry Clips

The Microcontroller Board and Power Supply Board remain attached to the Operator Interface Assembly by wired connectors.

4. The Microcontroller and Power Supply board are attached to either side of the Option board by male/female pin connectors. Use a gentle rocking motion and carefully apply pressure in a uniform direction to separate

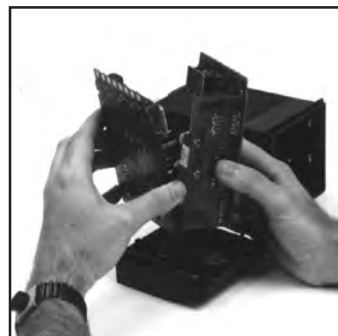

Photo 4. Separate Boards

one of the larger two boards from the Option Board (Photo 4). Be careful not to bend the connector pins. Separate the other board in the same manner.

Figure 2 (opposite page) shows the Microcontroller Board, Option Board and Power Supply Board.

To Add or Change Output Modules

The 500 Series units have provisions for four output modules. The units come factory configured with specified modules installed in appropriate locations. You can make field modifications by properly removing and/or adding the modules into the appropriate sockets.

Three of the output sockets are located on the Power Supply Circuit Board. A fourth output socket is located on the Option Board (refer to **Figure 2**).

5. A retention plate and tie wrap hold Output modules 1, 2, and 3 (on the Power Supply board) firmly in place. To remove the retention plate, snip the tie wrap with wire cutters (Photo 5).

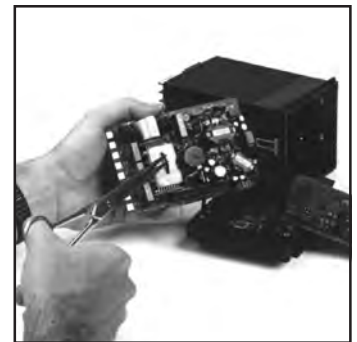

Photo 5.

Remove Retention Plate

CAUTION: Always snip the tie wrap on top of the Retention Plate, as shown in photo 5, to prevent damage to the surface mount components.

6. A disposable tie wrap holds Output module 4 (on the Option board) in place. To remove the module, snip the tie wrap (Photo 6).

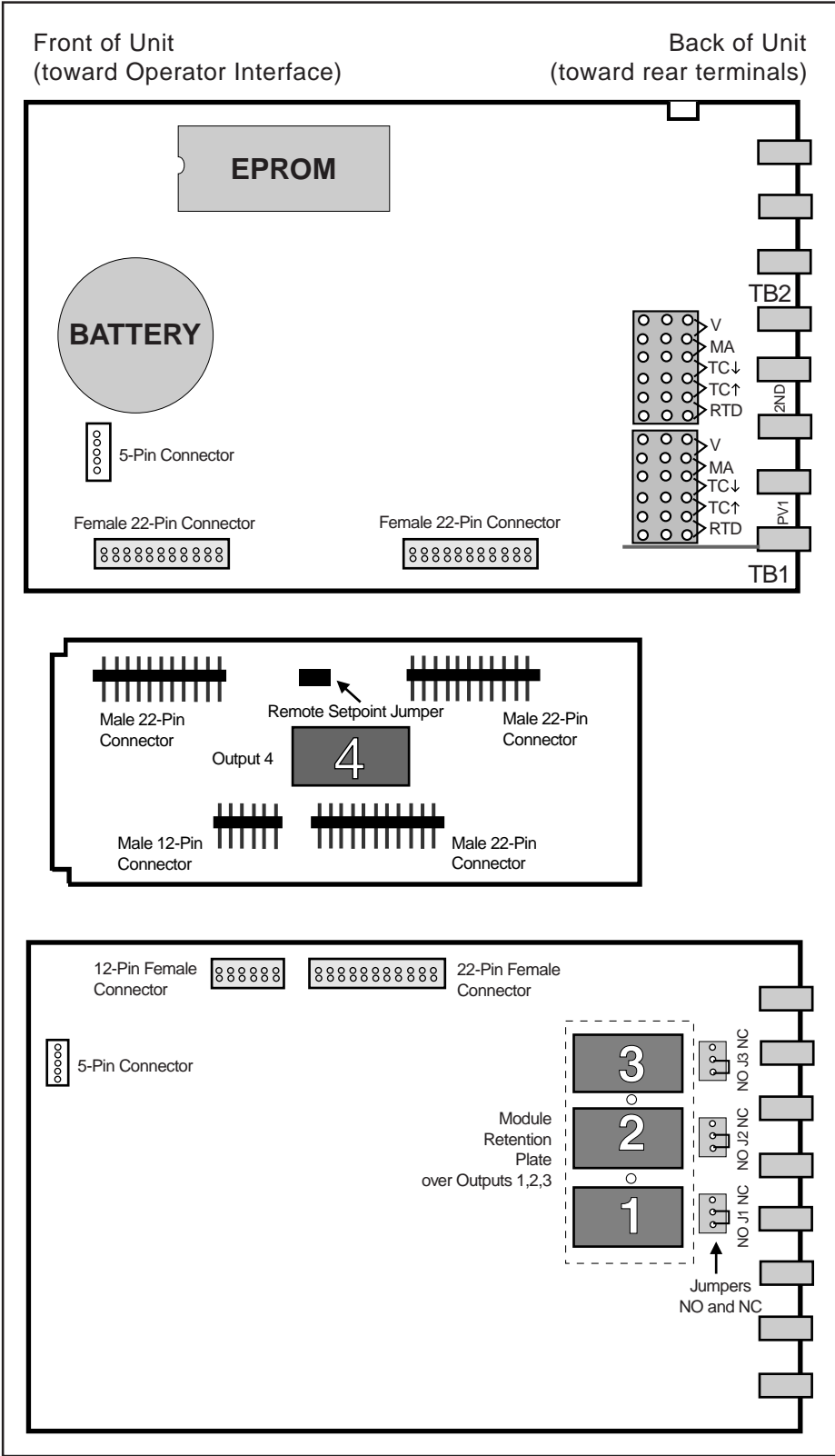

Photo 6.

Snip Tie Wrap on Mod. 4

7. Inspect each module before installation to make sure the pins are straight. Align the pins with the socket holes and carefully insert the module. Press down on the module to seat it firmly on the board.

Installation



NOTE:
If you replace the EPROM chip, you must align the notch facing the front of the unit.

NOTE:
The 5- and 22-Pin connectors on the boards are all keyed so they will only align one correct way.

Figure 2
Microcontroller Board,
Option Board,
and Power Supply Board

8. Replace tie wraps for the Retention Plate and for Output Module 4 with new ones.

Failure to use these devices may result in a loosening of the module and eventual failure. If you ordered a module separately, it should have come with a tie wrap. An extra set of tie wraps is available by ordering Part #535-665.

Note: For greatest accuracy, milliamp modules added for retransmission must be calibrated per instructions in Operator's Manual.

To Change the Option Board

9. (See Photos 3 and 4) Replace the existing Option board with the NEW one.

Note: When adding Option board for 5 digital inputs, associated screw terminal in the rear terminal block must be installed. (See information on page 1 for ordering a Screw Kit.)

To Change the Power Supply or Microcontroller (CPU) Board

10. For the Microcontroller Board, disconnect the 5-pin female connector that wires it to the Display Assembly. Reattach the connector to the new board. You can only orient the connector one way.
For the Power Supply Board, disconnect the 5-pin female connector that wires it to the Display Assembly. Reattach the connector to the new board. You can only orient the connector one way.

To Change the Display Assembly

11. Disconnect the 5-pin female connector that wires the Microcontroller Board to the Display Assembly. Disconnect the 5-pin female connector that wires the Power Supply Board to the Display Assembly.
12. Attach the new Display Assembly to the boards at the appropriate connectors.

CAUTION

Static discharge will cause damage to equipment. Always ground yourself with a wrist grounding strap when handling electronics to prevent static discharge.

CAUTION

Do not scratch the boards or bend the pins of the connectors.

To Change the EPROM

13. The EPROM is located on the Microcontroller Circuit board (**Figure 2**). It has a white label that list the part number and software revision level. Use an I.C. Extractor to carefully remove the EPROM. If you do not have an I.C. extractor, gently use a small flat blade screwdriver to pry up the EPROM. DO NOT bend the EPROM legs.
14. Carefully insert the new EPROM. To position correctly, match the notched end of the EPROM to the markings on the board. The notched end will face towards the display. Make sure all pins are in the socket.

To Reassemble the Unit

15. (See **Figure 2**) Align the connector pins on the Option Board with the connector sockets on the Microcontroller and Power Supply boards. Squeeze them together, making certain all three are properly seated against one another. Check along the side edges for gaps. Make sure the conector is properly aligned. Also, check that the cable assemblies are not pinched.
16. (See **Figure 2**) Align the board assembly with the front face assembly, with the Option board at the bottom (see **Figure 1**). Reinstall the retention clips. Align the boards into the slots of the front face assembly and the clips will snap into place.
17. When you are ready to reassemble the unit, align the boards in the chassis with the case's top and bottom grooves. Press firmly to slide the chassis into the case. If you have difficulty, check that you have properly oriented the chassis, and there are no screws interfering with the case.
18. Carefully insert and align screws. Tighten them until the bezel is seated firmly against the gasket. DO NOT OVERTIGHTEN.
19. If may be necessary to re-configure the software features of your controller or station. Please refer to your User's Manual.
20. To maintain NEMA 4X Rating, you may need new mounting gaskets, order part #535-662. Refer to your user's manual.

RETURN PROCEDURES

To return equipment to Moore Industries for repair, follow these four steps:

1. Call Moore Industries and request a Returned Material Authorization (RMA) number.

Warranty Repair –

If you are unsure if your unit is still under warranty, we can use the unit's serial number to verify the warranty status for you over the phone. Be sure to include the RMA number on all documentation.

Non-Warranty Repair –

If your unit is out of warranty, be prepared to give us a Purchase Order number when you call. In most cases, we will be able to quote you the repair costs at that time. The repair price you are quoted will be a "Not To Exceed" price, which means that the actual repair costs may be less than the quote. Be sure to include the RMA number on all documentation.

2. Provide us with the following documentation:
 - a) A note listing the symptoms that indicate the unit needs repair
 - b) Complete shipping information for return of the equipment after repair
 - c) The name and phone number of the person to contact if questions arise at the factory
3. Use sufficient packing material and carefully pack the equipment in a sturdy shipping container.
4. Ship the equipment to the Moore Industries location nearest you.

The returned equipment will be inspected and tested at the factory. A Moore Industries representative will contact the person designated on your documentation if more information is needed. The repaired equipment, or its replacement, will be returned to you in accordance with the shipping instructions furnished in your documentation.

WARRANTY DISCLAIMER

THE COMPANY MAKES NO EXPRESS, IMPLIED OR STATUTORY WARRANTIES (INCLUDING ANY WARRANTY OF MERCHANTABILITY OR OF FITNESS FOR A PARTICULAR PURPOSE) WITH RESPECT TO ANY GOODS OR SERVICES SOLD BY THE COMPANY. THE COMPANY DISCLAIMS ALL WARRANTIES ARISING FROM ANY COURSE OF DEALING OR TRADE USAGE, AND ANY BUYER OF GOODS OR SERVICES FROM THE COMPANY ACKNOWLEDGES THAT THERE ARE NO WARRANTIES IMPLIED BY CUSTOM OR USAGE IN THE TRADE OF THE BUYER AND OF THE COMPANY, AND THAT ANY PRIOR DEALINGS OF THE BUYER WITH THE COMPANY DO NOT IMPLY THAT THE COMPANY WARRANTS THE GOODS OR SERVICES IN ANY WAY.

ANY BUYER OF GOODS OR SERVICES FROM THE COMPANY AGREES WITH THE COMPANY THAT THE SOLE AND EXCLUSIVE REMEDIES FOR BREACH OF ANY WARRANTY CONCERNING THE GOODS OR SERVICES SHALL BE FOR THE COMPANY, AT ITS OPTION, TO REPAIR OR REPLACE THE GOODS OR SERVICES OR REFUND THE PURCHASE PRICE. THE COMPANY SHALL IN NO EVENT BE LIABLE FOR ANY CONSEQUENTIAL OR INCIDENTAL DAMAGES EVEN IF THE COMPANY FAILS IN ANY ATTEMPT TO REMEDY DEFECTS IN THE GOODS OR SERVICES, BUT IN SUCH CASE THE BUYER SHALL BE ENTITLED TO NO MORE THAN A REFUND OF ALL MONIES PAID TO THE COMPANY BY THE BUYER FOR PURCHASE OF THE GOODS OR SERVICES.

ANY CAUSE OF ACTION FOR BREACH OF ANY WARRANTY BY THE COMPANY SHALL BE BARRED UNLESS THE COMPANY RECEIVES FROM THE BUYER A WRITTEN NOTICE OF THE ALLEGED DEFECT OR BREACH WITHIN TEN DAYS FROM THE EARLIEST DATE ON WHICH THE BUYER COULD REASONABLY HAVE DISCOVERED THE ALLEGED DEFECT OR BREACH, AND NO ACTION FOR THE BREACH OF ANY WARRANTY SHALL BE COMMENCED BY THE BUYER ANY LATER THAN TWELVE MONTHS FROM THE EARLIEST DATE ON WHICH THE BUYER COULD REASONABLY HAVE DISCOVERED THE ALLEGED DEFECT OR BREACH.

RETURN POLICY

For a period of thirty-six (36) months from the date of shipment, and under normal conditions of use and service, Moore Industries ("The Company") will at its option replace, repair or refund the purchase price for any of its manufactured products found, upon return to the Company (transportation charges prepaid and otherwise in accordance with the return procedures established by The Company), to be defective in material or workmanship. This policy extends to the original Buyer only and not to Buyer's customers or the users of Buyer's products, unless Buyer is an engineering contractor in which case the policy shall extend to Buyer's immediate customer only. This policy shall not apply if the product has been subject to alteration, misuse, accident, neglect or improper application, installation, or operation. THE COMPANY SHALL IN NO EVENT BE LIABLE FOR ANY INCIDENTAL OR CONSEQUENTIAL DAMAGES.



The Interface Solution Experts • www.miinet.com

United States • info@miinet.com
Tel: (818) 894-7111 • FAX: (818) 891-2816
Australia • sales@mooreind.com.au
Tel: (02) 8536-7200 • FAX: (02) 9525-7296

Belgium • info@mooreind.be
Tel: 03/448.10.18 • FAX: 03/440.17.97
The Netherlands • sales@mooreind.nl
Tel: (0)344-617971 • FAX: (0)344-615920

China • sales@mooreind.sh.cn
Tel: 86-21-62481120 • FAX: 86-21-62490635
United Kingdom • sales@mooreind.com
Tel: 01293 514488 • FAX: 01293 387752

April 2016

Purpose

This supplement is to address the updated Micro Controller Board with removable Lithium Battery. Older models required to be serviced by Moore Industries to replace Lithium Battery which was soldered directly on the board, this is an inconvenience and has been resolved with a Micro Controller Board that has a replaceable Lithium Battery slot.

To replace battery in your 500 Series unit follow previous instructions found in M500 V6. Use a flat head screwdriver to release battery and replace.

You can order replacement directly fro Moore Industries using this part number 800-867-52 or an equivalent CR2450 3V Coin Cell Lithium Battery.

Figure 1. Removable Lithium Battery

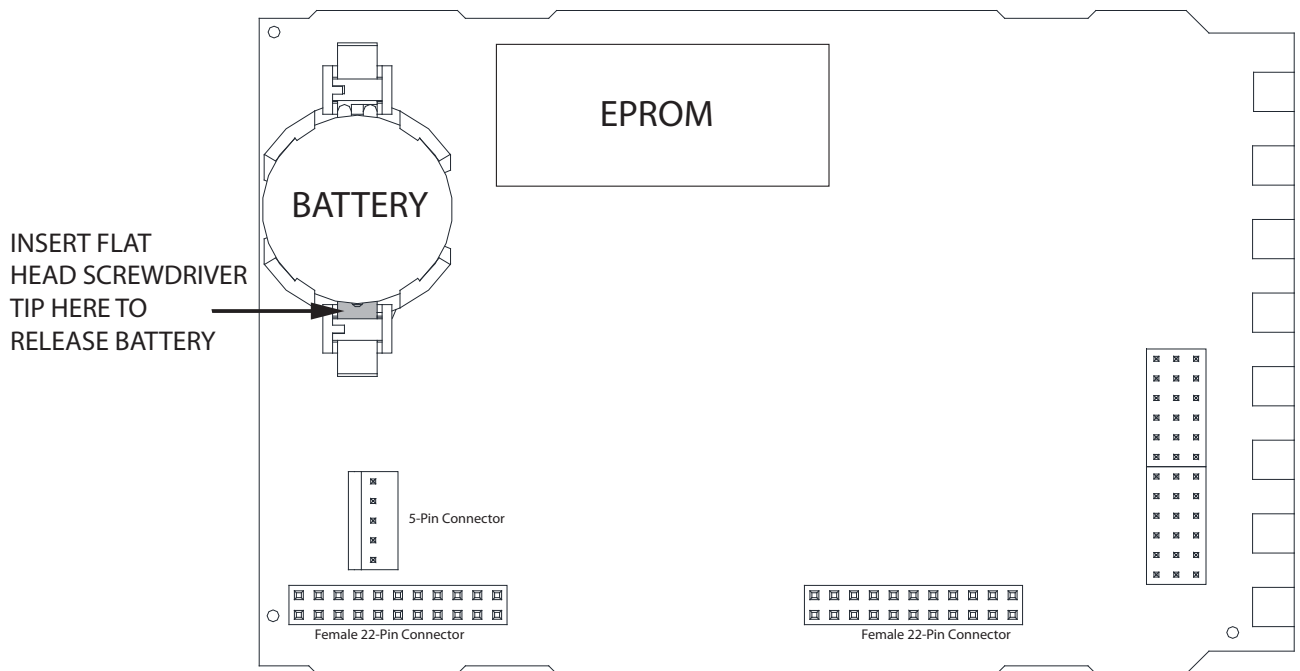

RETURN PROCEDURES

To return equipment to Moore Industries for repair, follow these four steps:

1. Call Moore Industries and request a Returned Material Authorization (RMA) number.

Warranty Repair –

If you are unsure if your unit is still under warranty, we can use the unit's serial number to verify the warranty status for you over the phone. Be sure to include the RMA number on all documentation.

Non-Warranty Repair –

If your unit is out of warranty, be prepared to give us a Purchase Order number when you call. In most cases, we will be able to quote you the repair costs at that time. The repair price you are quoted will be a "Not To Exceed" price, which means that the actual repair costs may be less than the quote. Be sure to include the RMA number on all documentation.

2. Provide us with the following documentation:
 - a) A note listing the symptoms that indicate the unit needs repair
 - b) Complete shipping information for return of the equipment after repair
 - c) The name and phone number of the person to contact if questions arise at the factory
3. Use sufficient packing material and carefully pack the equipment in a sturdy shipping container.
4. Ship the equipment to the Moore Industries location nearest you.

The returned equipment will be inspected and tested at the factory. A Moore Industries representative will contact the person designated on your documentation if more information is needed. The repaired equipment, or its replacement, will be returned to you in accordance with the shipping instructions furnished in your documentation.

WARRANTY DISCLAIMER

THE COMPANY MAKES NO EXPRESS, IMPLIED OR STATUTORY WARRANTIES (INCLUDING ANY WARRANTY OF MERCHANTABILITY OR OF FITNESS FOR A PARTICULAR PURPOSE) WITH RESPECT TO ANY GOODS OR SERVICES SOLD BY THE COMPANY. THE COMPANY DISCLAIMS ALL WARRANTIES ARISING FROM ANY COURSE OF DEALING OR TRADE USAGE, AND ANY BUYER OF GOODS OR SERVICES FROM THE COMPANY ACKNOWLEDGES THAT THERE ARE NO WARRANTIES IMPLIED BY CUSTOM OR USAGE IN THE TRADE OF THE BUYER AND OF THE COMPANY, AND THAT ANY PRIOR DEALINGS OF THE BUYER WITH THE COMPANY DO NOT IMPLY THAT THE COMPANY WARRANTS THE GOODS OR SERVICES IN ANY WAY.

ANY BUYER OF GOODS OR SERVICES FROM THE COMPANY AGREES WITH THE COMPANY THAT THE SOLE AND EXCLUSIVE REMEDIES FOR BREACH OF ANY WARRANTY CONCERNING THE GOODS OR SERVICES SHALL BE FOR THE COMPANY, AT ITS OPTION, TO REPAIR OR REPLACE THE GOODS OR SERVICES OR REFUND THE PURCHASE PRICE. THE COMPANY SHALL IN NO EVENT BE LIABLE FOR ANY CONSEQUENTIAL OR INCIDENTAL DAMAGES EVEN IF THE COMPANY FAILS IN ANY ATTEMPT TO REMEDY DEFECTS IN THE GOODS OR SERVICES, BUT IN SUCH CASE THE BUYER SHALL BE ENTITLED TO NO MORE THAN A REFUND OF ALL MONIES PAID TO THE COMPANY BY THE BUYER FOR PURCHASE OF THE GOODS OR SERVICES.

ANY CAUSE OF ACTION FOR BREACH OF ANY WARRANTY BY THE COMPANY SHALL BE BARRED UNLESS THE COMPANY RECEIVES FROM THE BUYER A WRITTEN NOTICE OF THE ALLEGED DEFECT OR BREACH WITHIN TEN DAYS FROM THE EARLIEST DATE ON WHICH THE BUYER COULD REASONABLY HAVE DISCOVERED THE ALLEGED DEFECT OR BREACH, AND NO ACTION FOR THE BREACH OF ANY WARRANTY SHALL BE COMMENCED BY THE BUYER ANY LATER THAN TWELVE MONTHS FROM THE EARLIEST DATE ON WHICH THE BUYER COULD REASONABLY HAVE DISCOVERED THE ALLEGED DEFECT OR BREACH.

RETURN POLICY

For a period of thirty-six (36) months from the date of shipment, and under normal conditions of use and service, Moore Industries ("The Company") will at its option replace, repair or refund the purchase price for any of its manufactured products found, upon return to the Company (transportation charges prepaid and otherwise in accordance with the return procedures established by The Company), to be defective in material or workmanship. This policy extends to the original Buyer only and not to Buyer's customers or the users of Buyer's products, unless Buyer is an engineering contractor in which case the policy shall extend to Buyer's immediate customer only. This policy shall not apply if the product has been subject to alteration, misuse, accident, neglect or improper application, installation, or operation. THE COMPANY SHALL IN NO EVENT BE LIABLE FOR ANY INCIDENTAL OR CONSEQUENTIAL DAMAGES.



United States • info@miinet.com
Tel: (818) 894-7111 • FAX: (818) 891-2816
Australia • sales@mooreind.com.au
Tel: (02) 8536-7200 • FAX: (02) 9525-7296

Belgium • info@mooreind.be
Tel: 03/448.10.18 • FAX: 03/440.17.97
The Netherlands • sales@mooreind.nl
Tel: (0)344-617971 • FAX: (0)344-615920

China • sales@mooreind.sh.cn
Tel: 86-21-62481120 • FAX: 86-21-62490635
United Kingdom • sales@mooreind.com
Tel: 01293 514488 • FAX: 01293 387752

The Interface Solution Experts • www.miinet.com